

Multitron Standard

Operating manual



Multitron Standard – Rel. 2.0 / 230 V

Incubator shaker

FW: 1.3.0

Doc-ID: D001, 7, en_GB – Original

Art. 81026

More information about the product is
available online at:
www.infors-ht.com/en/multitron-standard



INFORS HT

Headoffice, Switzerland
Rittergasse 27
CH-4103 Bottmingen

T +41 (0)61 425 77 00

info@infors-ht.com
service@infors-ht.com

Supplemental directives

About this Manual



This manual enables the safe and efficient handling of the device. All the information and instructions in this operating manual comply with the current standards, legal regulations and the latest technological developments.

This operating manual is a component part of the device. It must be kept near the device unit and be accessible to staff at all times. All persons working on or with the device must read the operating manual thoroughly and fully understand its contents before beginning any work. Adhering to all the safety notes and operating instructions in this manual is essential to ensure that work is carried out safely.

The scope of delivery may differ from the explanations, descriptions and figures in this operating manual due to special designs, additional options specified on ordering and the latest technical/mechanical modifications.

This manual contains illustrations to aid general understanding. These may differ from the actual device as supplied.

Customer Service and Services

The customer service of the manufacturer or the local licensed dealer is at your disposal for technical advice and specialist enquiries (contact details see → <https://www.infors-ht.com/en/contact/>). Due to their familiarity with the potential applications of the device, the Customer Service team is able to provide information on whether the unit can be used for a specific application or modified to handle the planned process.

Declaration of Conformity

The device meets the general requirements of the following standards:

- Machinery Directive 2006/42/EC
- EMC Directive 2014/30/EU

The declaration of conformity in the sense of the Machinery Directive, Annex II 1 A is attached to the operating manual.

Table of contents

Table of contents

1 Overview of the Device.....	8
1.1 Basic Unit.....	8
1.2 Parameters.....	10
1.3 Operating and Display Elements.....	10
1.3.1 Operating Elements.....	11
1.3.2 Display Elements.....	12
1.3.3 View Boxes.....	13
2 Safety and Responsibility.....	14
2.1 Explanation of Special Displays.....	14
2.1.1 Warning Messages.....	14
2.1.2 Other Messages.....	14
2.2 Intended Use, Incorrect Use and Misuse.....	15
2.3 Cultivation Vessels to be Used.....	16
2.4 Qualified Personnel.....	17
2.4.1 Operator.....	17
2.4.2 Technician.....	18
2.4.3 INFORS HT Service Technician or Licensed Dealer.....	18
2.5 Unauthorized Persons.....	18
2.6 Responsibility of the Provider.....	18
2.7 Residual Risks.....	19
2.8 Safety Features.....	21
2.9 Warning Symbols on the Device.....	22
2.10 Declaration of Decontamination.....	22
3 Setup and Function.....	23
3.1 Functions.....	23
3.1.1 Shaking Function.....	23
3.1.2 Temperature Control (Heating).....	25
3.1.3 Optional Cooling Function.....	26
3.2 Working Light.....	27

Table of contents

3.3	Connections and Interfaces.....	27
3.3.1	Mains Connection.....	27
3.3.2	Ethernet Interface.....	28
3.3.3	USB Connection.....	28
3.4	Openings.....	29
3.4.1	Discharge Outlet.....	29
3.4.2	Air Vents.....	29
3.5	Substructure.....	30
3.6	Operating and Display Elements.....	30
3.6.1	Power Switch.....	30
3.6.2	Operating Panel.....	31
3.7	Markings on the Device.....	31
3.7.1	Identification Plate.....	31
3.7.2	Identification of the Throw.....	32
4	Accessories.....	33
4.1	Trays.....	33
4.1.1	Universal Table Tray.....	35
4.1.2	Tray with Steel Clamps.....	36
4.1.3	Tray with Pin Holders.....	36
4.1.4	Tray with Clamping Assembly.....	37
4.1.5	Tray with Sliding Bars.....	39
4.1.6	Tray with Sticky Stuff.....	40
4.2	Clamps and Other Holders.....	43
4.2.1	Clamps.....	43
4.2.2	Test Tube Holder.....	45
4.3	Box for Microtitre Plates.....	45
4.4	eve®.....	48
5	Installation and Commissioning.....	49
5.1	Operating Conditions at the Installation Location.....	49
5.2	Requirements for the Mains Connection.....	50
5.3	Minimum Distances to the Device.....	51

Table of contents

6	Operation.....	53
6.1	Switching the Device on.....	53
6.2	Loading the Device.....	53
6.2.1	Opening the Door.....	54
6.2.2	Inserting and Removing the Tray.....	55
6.2.3	Mounting the Holders.....	57
6.2.4	Tips & Tricks for Loading the Tray.....	59
6.3	Setting, Activating and Deactivating Parameters.....	60
6.4	Timer Function.....	61
6.4.1	Overview.....	61
6.4.2	Programming Timer.....	63
6.4.3	Displaying the Remaining Time.....	66
6.4.4	Stopping the Timer.....	67
6.5	Using eve® to Operate the Device.....	68
6.6	Using the Operating Time Counter.....	69
6.7	Switching off the Device.....	70
6.8	Behavior in Case of a Power Interruption.....	71
7	Rectifying Faults.....	72
7.1	Safety Notes.....	72
7.2	Messages in the View Boxes.....	72
7.2.1	Alarm Messages.....	73
7.2.2	Error Messages.....	74
7.3	Fault Tables.....	75
7.4	Replacing Device Fuses.....	78
7.5	Returning for Repair.....	78
8	Cleaning and Maintenance.....	79
8.1	Maintenance.....	79
8.2	Cleaning and Disinfection.....	80
8.2.1	Cleaning the Device.....	80
8.2.2	Disinfecting the Device.....	81
8.2.3	Cleaning and Disinfecting the Base Tray.....	81

Table of contents

9 Transport and Storage..... 83

 9.1 Transport..... 83

 9.2 Storage..... 83

10 Disposal..... 84

11 Technical Data..... 85

 11.1 Dimension Drawings..... 85

 11.2 Specifications of the Basic Unit..... 87

 11.2.1 Weight..... 87

 11.2.2 Dimensions..... 88

 11.2.3 Electrical Connection and Power Values..... 88

 11.2.4 Working Light..... 89

 11.2.5 Materials..... 89

 11.2.6 Emissions..... 89

 11.2.7 Operating Conditions..... 90

 11.2.8 Protection Type..... 90

 11.2.9 Operating and Auxiliary Materials..... 91

 11.3 Specifications of Parameters..... 91

 11.3.1 Shaker Drive..... 91

 11.3.2 Temperature Control..... 93

 11.3.3 Ideal Loading Weights..... 94

12 EU Declaration of Conformity..... 95

13 Index..... 97

Overview of the Device

1 Overview of the Device

1.1 Basic Unit

Exterior

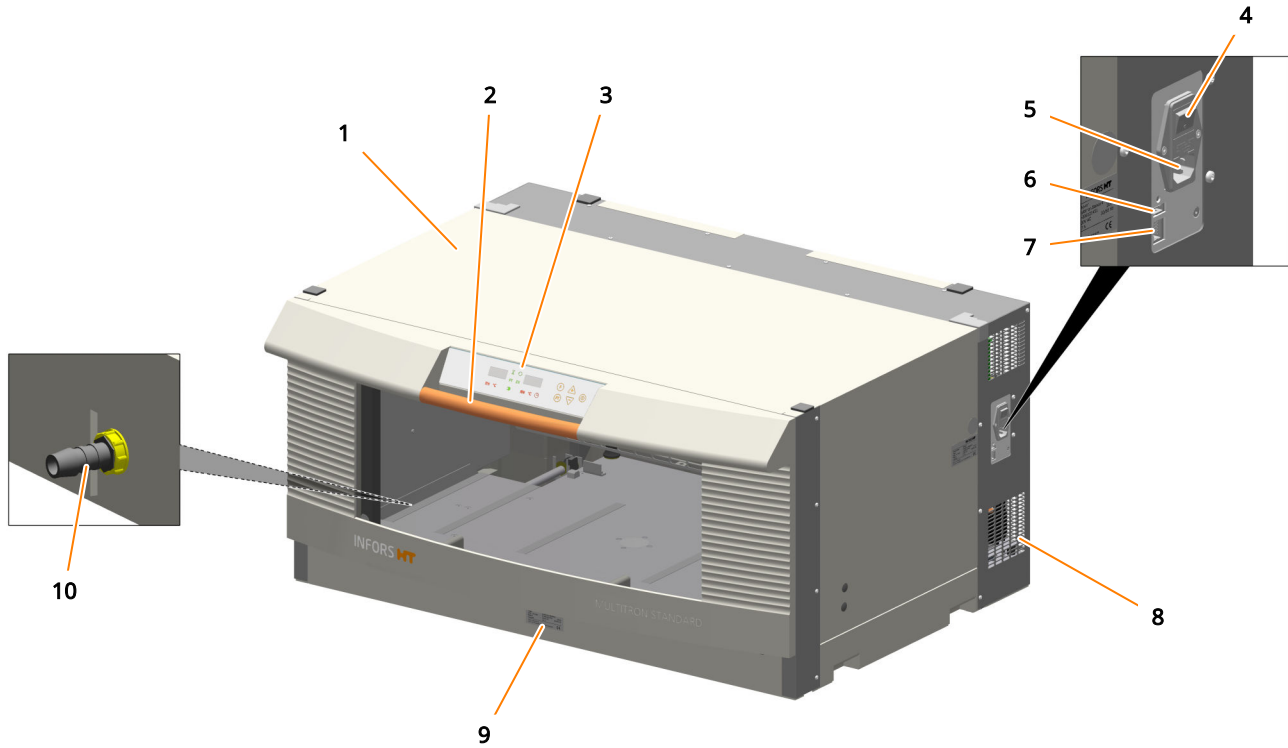

- | | | | |
|---|------------------------------------|----|--|
| 1 | Casing | 6 | USB connection (only for service purposes) |
| 2 | Door handle | 7 | Ethernet interface |
| 3 | Operating panel | 8 | Air vents |
| 4 | Power switch | 9 | Identification plate (2) |
| 5 | Mains connection with device fuses | 10 | Discharge outlet |

Interior

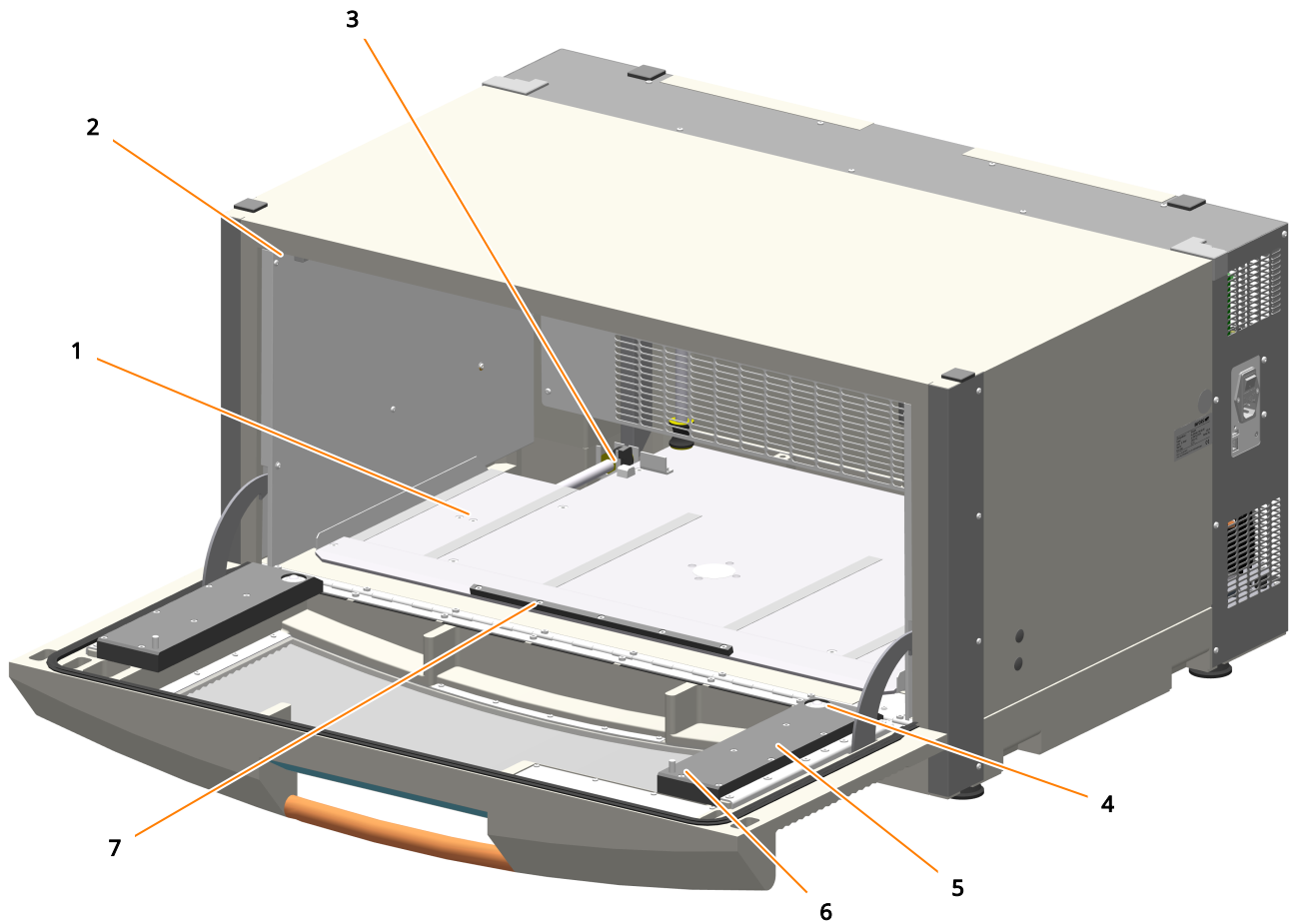

- 1 Table
- 2 Working light
- 3 Tray lock
- 4 Cylindrical ball caster

- 5 Slide rail
- 6 Screw-mounted pin
- 7 Stop bar

Short Description

The Multitron Standard incubator shaker is used to cultivate microorganisms or cell cultures in a laboratory environment. The basic version of the device is fitted with a shaker drive and a heater. Depending on which version of the device, it will come with either a 25 mm or a 50 mm throw. The device can also be fitted with an optional cooling system mounted on the top of the device.

The device can be operated either locally, using the operating panel on the front of the device, or remotely, using a computer connected to the device via an Ethernet interface.

Overview of the Device

1.2 Parameters

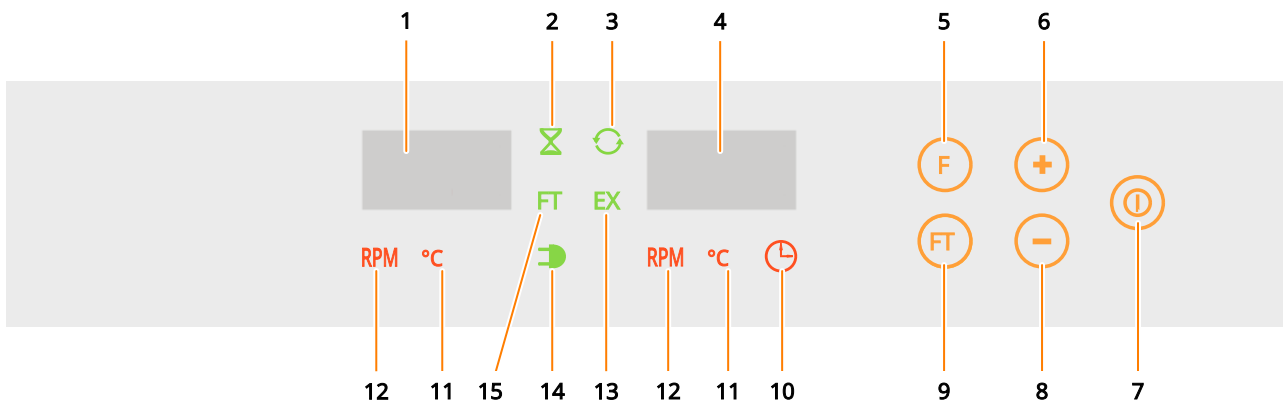

Parameter	Display	Unit	Additional information
Temperature		°C	The temperature that can actually be achieved depends on a variety of factors (such as the ambient temperature around the device, the ventilation and the temperature of the other device in the stack). ➔ Chapter 11.3.2 'Temperature Control' on page 93
Rotation speed		min ⁻¹	The maximum permissible rotation speed depends on the throw, the position of the device in a stack (top and bottom unit), and the load on the tray (mass). ➔ Chapter 11.3.1 'Shaker Drive' on page 91
Timer			The timer function allows you to make timed changes to the parameters. You can do this by defining two phases with different setpoints. You can program the following modes: <ul style="list-style-type: none"> One-time change from phase 1 to 2 (e.g. if you want to reduce the temperature after a certain amount of time) Cyclical changing between phases 1 and 2 (e.g. for simulating day and night) ➔ Chapter 6.4.1 'Timer Function' on page 61

1.3 Operating and Display Elements







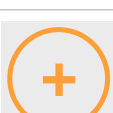
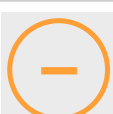

- | | |
|---|---|
| 1 View box, left | 9 FT button (select parameters for next phase) |
| 2 Function symbol for <i>timer active</i> | 10 Parameter symbol for <i>timer</i> |
| 3 Function symbol for <i>cycle active</i> | 11 Parameter symbol for <i>temperature</i> |
| 4 View box, right | 12 Parameter symbol for <i>rotation speed</i> |
| 5 F button (parameter selection) | 13 Function symbol for <i>external (EX)</i> |
| 6 Plus button | 14 Function symbol for <i>power supply On/Off</i> |
| 7 On/Off button | 15 Function symbol for <i>next phase (FT)</i> |
| 8 Minus button | |

1.3.1 Operating Elements

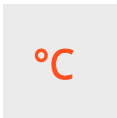
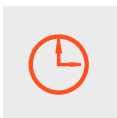
Operating element	Designation	Function
	On/Off button	The On/Off button is used to activate or deactivate the selected parameter.
	F button	The F button can be used to select the device's various parameters one after the other so that they can be adjusted and activated as necessary.
	FT button	The FT button can be used to select the device's various parameters one after the other so that they can be adjusted for the next phase. The FT button is only ever used in conjunction with the timer function.
	Plus button	The Plus button increases the values of the parameter setpoints or the time of the timer function. When the button is held down, the display runs up the specified value range in increasingly large intervals.
	Minus button	The Minus button decreases the values of the parameter setpoints or the time of the timer function. When the button is held down, the display runs down the specified value range in increasingly large intervals.

Overview of the Device

1.3.2 Display Elements

Symbol	Designation	Meaning
	<i>Rotation speed</i>	Indicates that the rotation speed (setpoint or actual value) is being displayed in the corresponding view box.
	<i>Temperature</i>	Indicates that the temperature (setpoint or actual value) is being displayed in the corresponding view box.
	<i>Timer</i>	Indicates that the timer function (length of time unit) can be adjusted.
	<i>External (EX)</i>	Indicates that the device is being accessed by an external device. This symbol also lights up, for example, if external software (e.g. eve®) is being used to access the device.
	<i>Cycle active</i>	Indicates that the cycle function (constant switching between phases 1 and 2) is active.
	<i>Next phase (FT)</i>	Indicates that the parameters for the second phase (FT) can be adjusted.
	<i>Timer active</i>	Indicates that the timer function is active.
	<i>Power supply On/Off</i>	Indicates that the device is switched on and the initialisation procedure is complete.

1.3.3 View Boxes

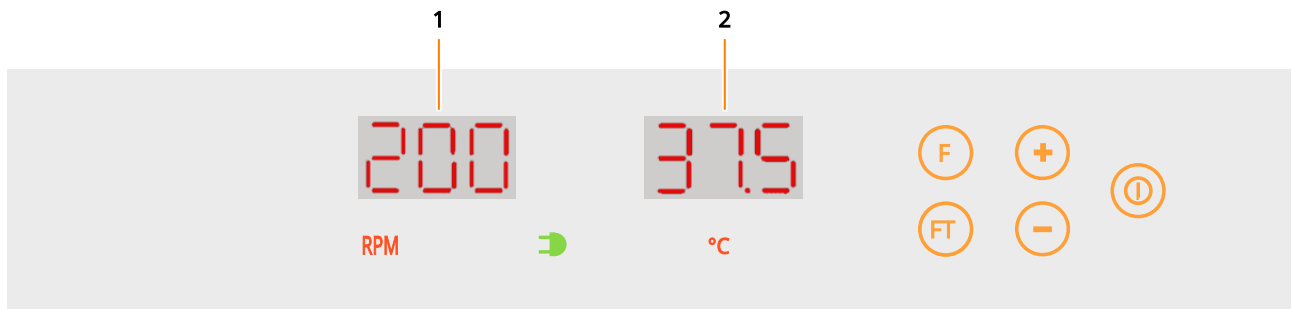

The two view boxes show the current actual values or setpoints of the parameters as well as alarm and error messages. In normal operation, the “Rotation speed” parameter (*RPM*) is displayed in the left view box (1) and the “Temperature” parameter (*°C*) is displayed in the right view box (2).

- The parameter is activated: The actual value is displayed.
- The parameter is deactivated. The display alternates between the setpoint and the message *OFF*.

The **F** button (or **FT** button when using the timer) can be used to navigate between parameters. The parameter that can be set is always displayed in the right view box. If no entry is made for 60 seconds the display returns to normal operation.

Time Information Displays



- From 0 to 99 minutes:
The time is displayed in *minutes (')*.



- From 1 hour, 40 minutes to 9 hours, 50 minutes:
The time is displayed in the format *hours (h) minutes x10*.



- From 10 to 95 hours:
The time is displayed in *hours (h)*.

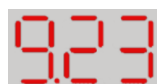

- From 4 days, 00 hours to 9 days, 23 hours:
The time is displayed in the format *days.hours*.

Fault Displays

For information on the alarms and error messages displayed in the view boxes, see → Chapter 7.2 ‘Messages in the View Boxes’ on page 72.

Safety and Responsibility

2 Safety and Responsibility

This chapter contains general information on safety when using the device. In the remaining chapters, warning messages are used only to highlight particular hazards directly arising from the actions being described.



It is essential to read the operating manual carefully – especially this chapter and the warning messages in the text – and to follow the instructions therein.

This chapter also refers to areas that are the responsibility of the provider due to certain risks arising from particular applications for which the device is used deliberately and with full awareness of the associated risks.

2.1 Explanation of Special Displays

2.1.1 Warning Messages

Warning messages in this manual are indicated by a colored bar and begin with a signal word that signifies the degree of the hazard.

WARNING

The signal word “WARNING” indicates a potentially dangerous situation that may result in severe or fatal injuries if not avoided.

CAUTION

The signal word “CAUTION” indicates a potentially dangerous situation that may result in minor injuries if not avoided.

NOTICE

The word “NOTICE” on a blue bar indicates a situation that may result in significant damage to property if not avoided.

2.1.2 Other Messages



Texts that are marked in this way provide useful tips and recommendations for ensuring efficient, fault-free operation of the device.

2.2 Intended Use, Incorrect Use and Misuse

Intended Use

The device is designed to be used as an incubator shaker for cultivating microorganisms or cell cultures under the following conditions:

- Cultivation of non-pathogenic microorganisms or cell cultures of risk category 1 in a biotechnology lab of biological protection level 1.
- Cultivation of pathogenic microorganisms or cell cultures of risk category 2 in a biotechnology lab of biological protection level 2.

When using the device in protection level 2, personnel are responsible for taking appropriate protective measures to ensure that organisms cannot escape uncontrollably due to flask breakage, unintentional detaching of the sterile seal or similar.

WARNING

The device is designed and built exclusively for the intended use described above.

Each instance of non-conventional use of the device is considered incorrect use and may lead to dangerous situations.

Intended use also includes following all the instructions in this manual, especially those relating to:

- The installation site
- Use of suitable cultivation vessels
- Personnel qualifications
- Permissible parameter setpoints
- Correct operation and maintenance

Incorrect Use/Misuse

Any failure to observe the requirements specified in this manual shall be deemed incorrect use, in particular, use of inappropriate cultivation vessels and/or unsuitable holders at rotation speeds that are too high.

Any use of the device outside the scope of the intended use as described above shall be deemed misuse. This also applies to applications for which the device is not designed, especially the following:

- The device is not protected against explosions. Use and manufacture of explosive gases as well as operating the device in the Ex area are therefore not permitted.
- The device is not designed to sufficiently protect the personnel if pathogenic organisms escape uncontrollably. Cultivation of pathogenic organisms of risk categories 3 and 4 is therefore not permitted.

Safety and Responsibility

To use the device for special applications not covered by conventional, intended use, the device must be modified and certified accordingly by the manufacturer.

Any use of the device outside of a biotechnology laboratory, i.e. in any environment in which the conditions required for the safety of the personnel cannot be met or cannot be met to their full extent, shall also be deemed misuse.

2.3 Cultivation Vessels to be Used

! NOTICE

Significant forces are applied to cultivation vessels, in particular in case of large vessels and high rotation speeds. Use of unsuitable or defective cultivation vessels can lead to glass breakage and therefore damage to property.

Approved Cultivation Vessels

The device has been designed for use with the following vessels using the holders designed specifically for them:

- Erlenmeyer flasks up to 5000 mL made of borosilicate glass (e.g. Schott Duran®) or high-grade plastic, such as polycarbonate (e.g. Corning®) etc.
- Fernbach flasks up to 3000 mL made of borosilicate glass (e.g. Schott Duran®) or high-grade plastic, such as polycarbonate (e.g. Corning®) etc.
- Thomson Optimum Growth® flasks up to 7000 mL
- Other vessels with the holders designed for them:
 - Test tubes
 - Centrifuge tubes
 - Microtitre plates
 - Deep-well plates

To avoid the vessels coming out of the clamps at very high rotation speeds, they might have to be secured using cable ties underneath the springs or some other suitable measure.

Cultivating Organisms of Risk Category 2

When cultivating pathogenic organisms of risk category 2, special measures must be taken to stop the organisms from escaping. The user is responsible for this.

When using the device under protection category 2, stainless steel clamps of the correct size must be used to affix the flasks. Due to limited resistance to disinfectants as well as the risk of unintentional detaching of flasks, Sticky Stuff adhesive matting is not suitable for this purpose.

We further recommend using disposable plastic flasks with screw tops and filter membranes. We recommend using adhesive tape to secure the top plate against coming off unintentionally. Using glass flasks with cotton wool or paper plugs is not sufficiently safe.

Trays with Sticky Stuff



For trays with Sticky Stuff, special provisions apply in relation to maximum permitted rotation speeds. These must be observed to prevent cultivation vessels from detaching.

For more information, see → Chapter 4.1.6 'Tray with Sticky Stuff' on page 40.

2.4 Qualified Personnel

2.4.1 Operator

The operator operates the device in the context of the intended use. Only persons who have been trained for working in a biotechnology laboratory can be considered for the role of operator. These include, for example:

- Process technicians in the fields of biotechnology and chemistry
- Biotechnologists (biotechnicians)
- Chemists with a specialization in biochemistry; chemists in the field of organic chemistry or biochemistry
- Life scientists (biologists) with special education in cytology, bacteriology, molecular biology, genetics, etc.
- Lab assistants (lab technicians) from various fields

To be allowed to operate the device, the operator must have received thorough training and have read and understood the operating manual.

The operator must be informed in a training session provided by the provider of the tasks delegated to the operator and the potential risks of improper conduct. Tasks that go beyond the scope of operation under normal conditions may only be performed by the operator if this is specified in the manual and the provider has explicitly entrusted said tasks to the operator.

Safety and Responsibility

Persons who are undergoing training or apprenticeships are only permitted to use the device under supervision and in accordance with the instructions of a trained and qualified technician.

2.4.2 Technician

The technician is an individual who, by virtue of their relevant professional education, training and/or experience, is competent to identify risks and prevent hazards arising from the use of the device. The technician is familiar with the environment in which they are operating and knows the relevant standards and regulations.

Technicians include, for example, the following groups of people:

- Qualified electricians
- Decontamination specialists
- Disassembly, disposal and recycling specialists

2.4.3 INFORS HT Service Technician or Licensed Dealer

Certain work may only be performed by the manufacturer's skilled personnel or by skilled personnel authorized by a licensed dealer. Other persons are not authorized to perform this work.

2.5 Unauthorized Persons

The term "unauthorized persons" applies to all persons who can access the work area but are not qualified to use the device in accordance with the aforementioned requirements.

Unauthorized persons are not permitted to operate the device or use it in any other way.

2.6 Responsibility of the Provider

Provider

The term "provider" applies to all persons who are responsible for making the device and the necessary infrastructure available. The provider bears a special level of responsibility with regard to the processes and the qualification and safety of the operators.

Provider Obligations

The device is used for industrial and scientific purposes. As such, the provider of the device is individually liable with regard to the legal requirements relating to occupational health and safety in a biotechnology laboratory. In particular:

- The provider is responsible for ensuring that the work and environmental regulations applicable in a biotechnology laboratory are observed.
- The provider must ensure that the device remains in safe and proper working condition throughout its entire term of use.
- The provider must ensure that all safety devices are fully functional and not disabled.
- The provider must ensure that the device is only operated by qualified personnel, and that said personnel receive sufficient training.
- The provider must ensure that the protective equipment required for working with the device is available and worn.
- The provider must ensure that this operating manual remains in the immediate vicinity of the device throughout its entire term of use.

2.7 Residual Risks

This chapter covers residual risks that are always present when using the device in accordance with normal, intended use.

Electric Current



The device is operated electronically. There is an immediate risk of fatal injury if contact is made with live parts. The following points must be observed in order to avoid the risk of fatal injury:

- In case of damage to insulation, disconnect the device from the power supply immediately and arrange for it to be repaired.
- Disconnect the device from the power supply before commencing any work on the electrical components.
- Always use qualified electricians for any work on the electrical components.
- Disconnect the device from the power supply before commencing any maintenance, cleaning or repair work.
- Do not bypass any fuses or take them out of operation.
- When replacing fuses, ensure they have the correct number of Amperes.
- If the power cable is defective, replace it with a power cable of the same type.
- Keep moisture away from live parts. It could cause a short circuit.
- Never remove covers from live parts.

Safety and Responsibility

Moving Parts



Moving parts are a general hazard posed by the device because body parts can be pinched or scratched when one is not careful.

However there is no risk of clothing or body parts being pulled into the device. The risk that fingers are pinched has been minimised by means of a sufficient distance between the tray and the casing and a stop mechanism that stops the shaker drive when the door is opened. Nonetheless, the cultivation flasks must only be moved when the table has come to a complete standstill.

Hot Surfaces



For applications that are performed with temperatures over 55 °C, there is a risk of burns on hot surfaces in the interior, on the tray or on the cultivation vessels.

For applications with temperatures of above 55 °C, wear heat-resistant protective gloves.

Dangerous Gases

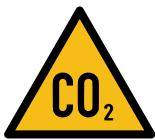

The use or production of dangerous – i.e. toxic or asphyxiant – gases entails a significant health risk, especially in small rooms. To prevent high emissions of dangerous gases, the following measures must be taken:

- The gas connections on the device must be checked before any cultivation using dangerous gases are initiated.
- Check the seals on the device at regular intervals and replace them if necessary.
- Check gas-carrying hoses for leaks at regular intervals.

Flammable or Explosive Substances



The use or production of flammable or explosive substances does not fall under the intended use, as the device is not explosion-proof. If the provider intends to use the device for such applications, it is essential to check the suitability of the device with the relevant local authorities.

There is a risk of explosions when using impure process gases: you must therefore only use process gases without impurities.

Corrosive or Toxic Substances



The use or production of corrosive or toxic substances entails a significant health risk. As such, special measures must be taken to protect personnel for such applications.

Since the device is used deliberately for such applications, it is the responsibility of the personnel to ensure that they have sufficient protection.

Pathogenic Organisms



The device is not approved for cultivation of pathogenic organisms of risk categories 3 and 4. In the context of intended use, it is nonetheless possible for pathogenic organisms and viruses to be cultivated. Contact with pathogenic organisms bears a significant health risk. Therefore, personnel are responsible for providing adequate protection.

Accessories and Spare Parts



Incorrect spare parts, imitations or spare parts that have not been authorized by the manufacturer and unauthorized accessories represent a significant safety risk. As such, we recommend procuring all spare parts and accessories from a licensed dealer or directly from the manufacturer.

2.8 Safety Features

The device comes with the following safety features:

Device Fuses

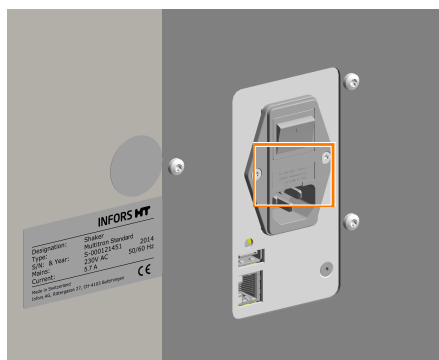

Two fuses protect the device from impermissibly high power input. The fuses are located right next to the mains connection on the left-hand side of the casing. For information on which fuses to use for which device type, see → Chapter 11.2.3 'Electrical Connection and Power Values' on page 88.

Overheating Shut-down

The heating of the device is protected against overheating by a fuse and a bimetal switch. These are triggered as soon as the maximum permissible temperature is exceeded and immediately turn off the heating.

Door Monitoring

The position of the door is monitored electronically. If the door is opened, all dangerous movements (shaker drive and fan) are stopped immediately. As soon as the door is fully closed again, the shaker drive and fan restart automatically.

Safety and Responsibility

2.9 Warning Symbols on the Device

The following warning symbols (stickers) are placed on the device:

Warning symbols	Position	Meaning
	On the casing of the device next to the mains connection.	Before starting any work on or with the device, observe the operating manual.

WARNING

Illegible or missing warning symbols on the device will lead to the personnel being exposed to risks that the warning symbols in question were designed to make them aware of.

It is the provider's responsibility to ensure that all the stickers with warning symbols on the device are always intact.

2.10 Declaration of Decontamination

When returning the device for repair, disassembly or disposal, a legally compliant declaration of decontamination is required for the safety of all involved and due to legal requirements. The following must be observed if this is the case:

- The device, component or accessory which is to be repaired must be entirely decontaminated before being sent to the manufacturer.
- The provider is therefore required to completely and truthfully fill out a declaration of decontamination, and have it signed by the person responsible.
- The declaration of decontamination must be affixed on the outer packaging in which the device is sent back.
- These forms can be obtained from the licensed dealer or the manufacturer.

i

If the return shipment is not accompanied by a signed and complete declaration of decontamination or it is not affixed to the outer packaging, the shipment will be returned unopened to the sender at their expense (see also T&C).

3 Setup and Function

3.1 Functions

3.1.1 Shaking Function

Mechanics

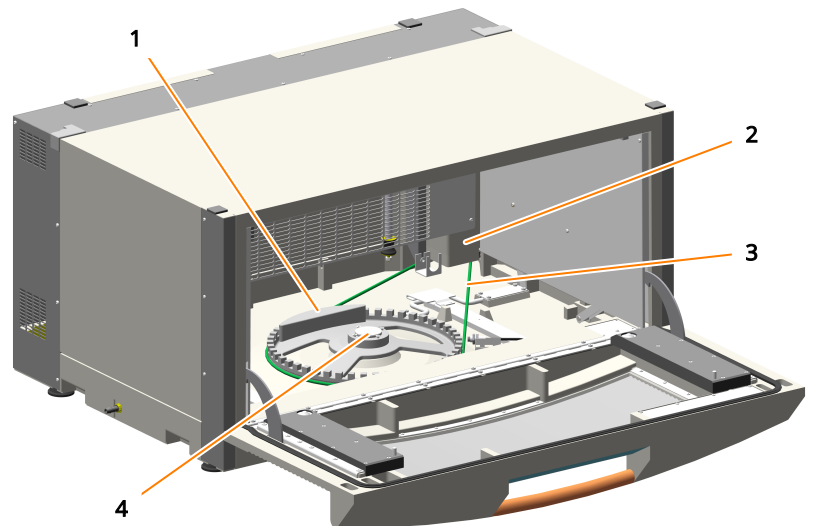

- 1 Counterweight
- 2 Electric motor
- 3 Drive belt
- 4 Drive hub

The table moves in circles at speeds of 20 to 400 min⁻¹. It is driven by an electric motor (2), which is connected to the device's counterweight (1) by a drive belt (3). To prevent injuries and facilitate easy handling of the cultivation flasks, the drive is switched off automatically as soon as the door is opened.

The counterweight used to balance the mass is fitted under the table. Depending on the design, the deflection of the circular movement is either 25 mm or 50 mm. The table moves in counter-clockwise circles.

Table

The table is connected to the drive hub by means of 4 hexalobular socket screw. The table is used to hold the 85 x 47 cm (type M) tray, various versions of which are available.

When the base tray requires cleaning, the 4 hexalobular socket screw can be undone, then the table can be lifted 30° to allow access (→ Chapter 8.2.3 'Cleaning and Disinfecting the Base Tray' on page 81).

Setup and Function



The load weights must be within the permissible range. If the load is too light or too heavy, this will prevent the table from running smoothly, leading to increased wear on the bearings and joints.

The permissible load weights depend on the position of the device in the stack, the throw and the shaking speed (→ Chapter 11.3.3 'Ideal Loading Weights' on page 94).

Operation

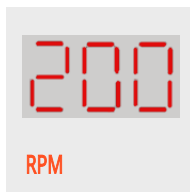

The shaker drive is operated using the "Rotation speed" parameter (RPM, Rotations Per Minute). For an exact description of how to set the parameters, see → Chapter 6.3 'Setting, Activating and Deactivating Parameters' on page 60.

3.1.2 Temperature Control (Heating)

Function

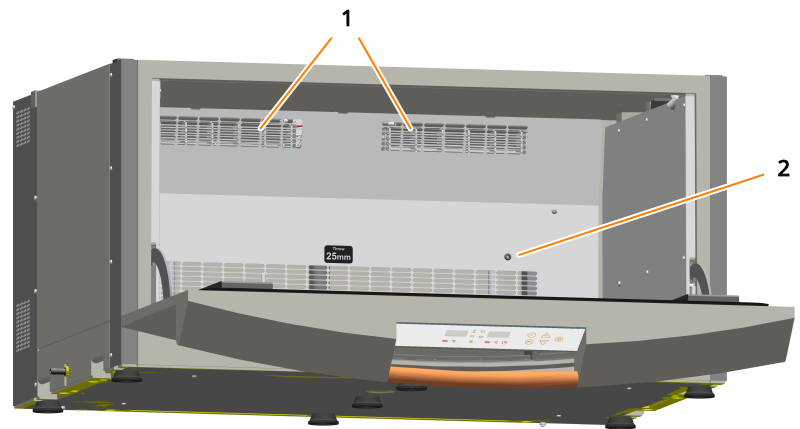

- 1 Cross-flow fan
- 2 Pt100 sensor

The temperature is controlled via two cross-flow fans (1), which are each equipped with a downstream heating element. The cross-flow fans ensure constant air circulation, and keep the temperature distribution in the incubation chamber as constant and gradient-free as possible.

The maximum possible temperature in the incubation chamber is 65°C, the minimum temperature is 6°C above the ambient temperature. In order to reach temperatures below the ambient temperature, the device can be fitted with an optional cooling system (→ Chapter 3.1.3 ‘Optional Cooling Function’ on page 26),

A Pt100 temperature sensor behind the rear wall (2, not visible) measures and controls the temperature.

Operation



The heater is operated using the “Temperature” (°C) parameter. For an exact description of how to set the parameters, see → Chapter 6.3 ‘Setting, Activating and Deactivating Parameters’ on page 60.

Setup and Function

3.1.3 Optional Cooling Function

Function

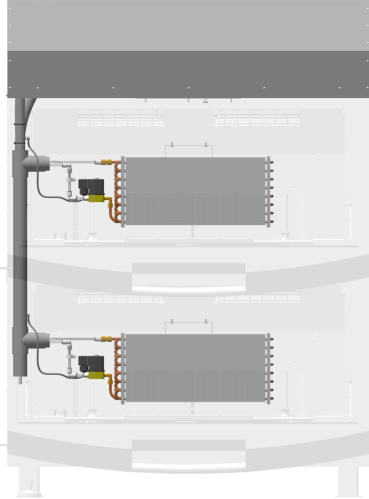

As the device is self-heating, a single unit can be operated at a temperature of up to approx. 6 °C above the ambient temperature without a cooling system. For processes that require temperatures significantly lower than this temperature, the device can be fitted with an optional cooling system.

The cooling unit is installed in a bracket mounted on the incubator shaker. The top cooling system cools all the devices in the stack. The cooling unit is a 2-circuit system with a cooling liquid tank, which must be filled with cooling liquid by INFORS HT prior to commissioning. The heat exchanger is located behind the rear wall of the incubation chamber.

Operation

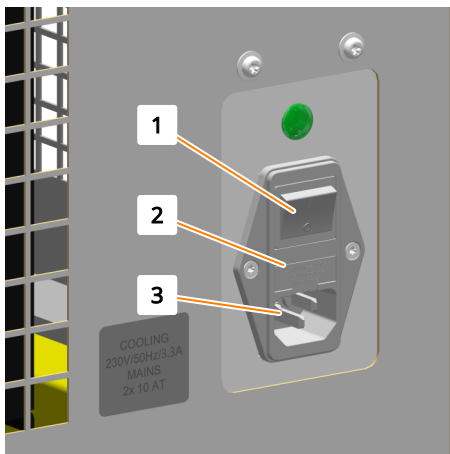

- 1 Power switch
- 2 Fuses
- 3 Mains connection

The cooling unit is an autonomous system and has its own power supply and power switch. This is located on the right-hand side of the cover.

Two device fuses next to the mains connection protect the cooling unit from impermissibly high power input.

Cooling is activated automatically, if this is necessary to reach the entered setpoint for the temperature.

3.2 Working Light

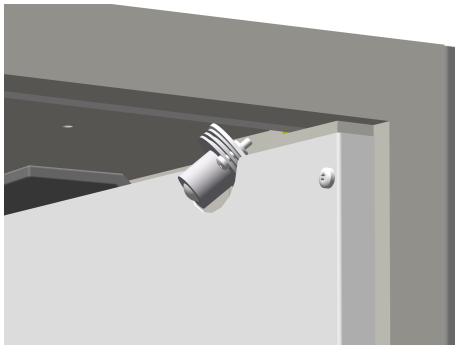

The device features two LED spots to illuminate the incubation chamber. These are located in the door area on the inside of the casing.

The working light is switched on automatically in the following situations:

- When the device is switched on using the power switch
- When the door is opened or closed
- When any of the buttons on the operating panel are pushed

The working light remains switched on for two minutes, then is switched off automatically.



The behaviour of the working light described above represents the standard configuration. If required, the working light can be configured to be constantly on or off. The working light setting is made in the service menu and can therefore only be changed by an INFORS HT service technician or licensed dealer.

3.3 Connections and Interfaces

3.3.1 Mains Connection

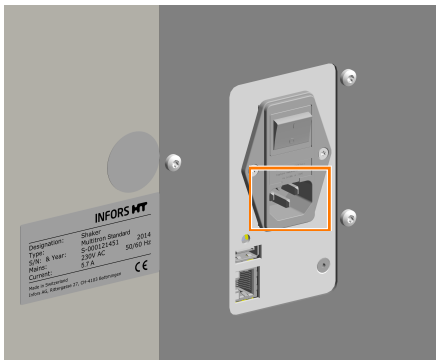

The mains connection is located on the right-hand side of the device. Three different versions of the device are available for different mains voltages:

- 230 V 50 Hz
- 230 V 60 Hz
- 115 V 60 Hz

Two device fuses immediately adjacent to the mains connection protect the device from impermissibly high power input.

The country-specific power cable required for connecting the power supply is included in the device's scope of delivery. If the power cable is defective, replace it with a power cable of the same type.

Prior to connecting the device, make sure that the voltage values of the device match those of the local mains voltage. The mains connection must be easily accessible at all times so that the device can be disconnected from the power supply quickly in case of an emergency.

For information on the electrical connection values, see [Chapter 11.2.3 'Electrical Connection and Power Values'](#) on page 88.

Setup and Function

3.3.2 Ethernet Interface

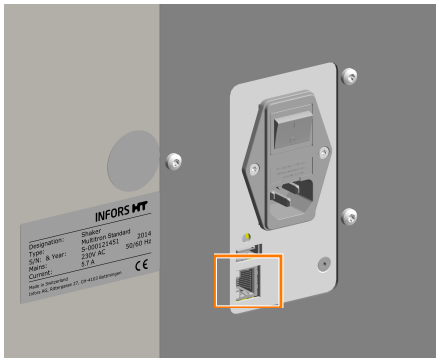

The device has an Ethernet interface (RJ45 socket). This is located on the right side of the device. The Ethernet interface can be used for the following purposes:

- Integration of the device into a network to control the device via eve® the bioprocess platform software.
- Control of the device via a laboratory management or monitoring system from a third-party manufacturer. For this purpose, a driver must be developed which translates the protocol used for the external software. The necessary documentation for the communication protocol can be ordered from INFORS HT.

The following data and states are transmitted via the Ethernet interface:

- From the device to the SCADA/bioprocess software: setpoints and actual values of the parameters as well as the status of the door and PIN function
- From the SCADA/bioprocess software to the device: sending new setpoints



Alarms and error messages are not transmitted via the Ethernet interface. Alarm limits can be defined either in eve® or in the SCADA system, depending on the application.

For more information on using the Ethernet interface, see Chapter 6.5 'Using eve® to Operate the Device' on page 68.

3.3.3 USB Connection

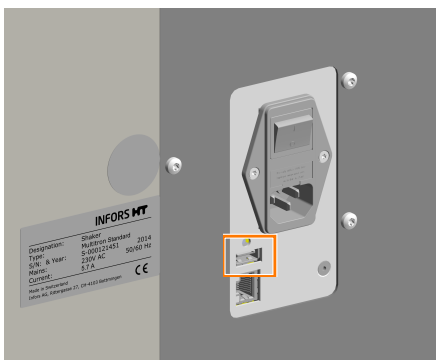

The USB port is reserved for service purposes and has no function in normal operation.

3.4 Openings

3.4.1 Discharge Outlet

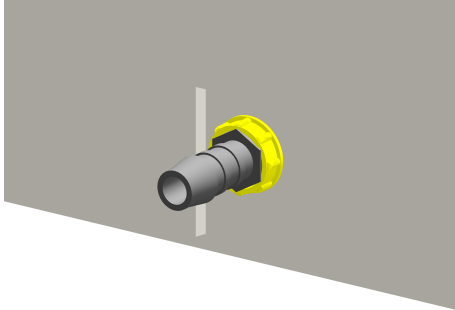

For draining spilled liquids, cleaning agents or accumulated condensation water, there is a discharge outlet at the bottom, almost in the middle of the left side of the casing.

The opening is sealed with a yellow plug on delivery. A hose nozzle (1/4 inch) for connecting a hose (Ø 10 mm) is provided.



In case of large fill volumes, we recommend installing the discharge hose to avoid the bearings coming into contact with liquid if a flask breaks.

If safety requirements must be met, e.g. when working with genetically modified organisms, the discharge hose must lead to a suitable, sealed receptacle. One example of such a receptacle would be an empty chemical container sealed with foil.

3.4.2 Air Vents

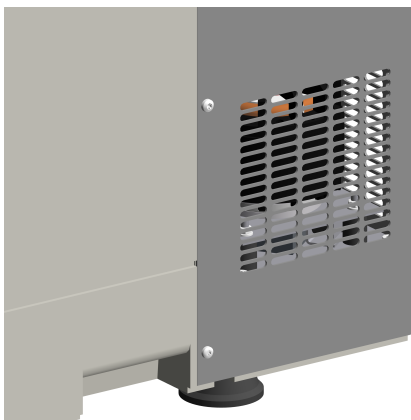

The device has air vents on both sides and the rear of the casing. When setting up the device, you must ensure that these air vents remain unobstructed in order to ensure that the exhaust air can be extracted without obstruction and none of the components overheat.

Setup and Function

3.5 Substructure

Different versions of the incubator shaker are available with different substructures:

	<p>Rubber Feet</p>	<p>Single units placed on a bench have a substructure comprising an earthing plate with 7 rubber feet. The rubber feet are bolted onto the earthing plate at a fixed height, and cannot be adjusted. As such, table top models must always be placed on an even surface.</p>
	<p>Low Base</p>	<p>Single and stacked units can be fitted with a 13 cm base. The base has an adjustable foot that can be used to level the device.</p>
	<p>High Base</p>	<p>Single units and two units stacked can be fitted with a 31 cm base. The base has an adjustable foot that can be used to level the device.</p>

3.6 Operating and Display Elements

3.6.1 Power Switch

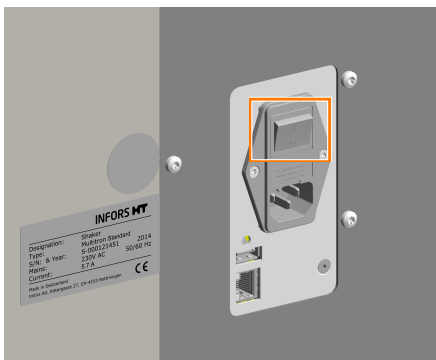

The power switch is located on the right-hand side of the device. In addition to normal switching on and off, the power switch also works as an emergency switch.



If the device is switched off, all parameter setpoints remain stored and the device restarts immediately when it is switched on again.

3.6.2 Operating Panel

All device functions can be controlled directly via the operating panel on the front of the device.

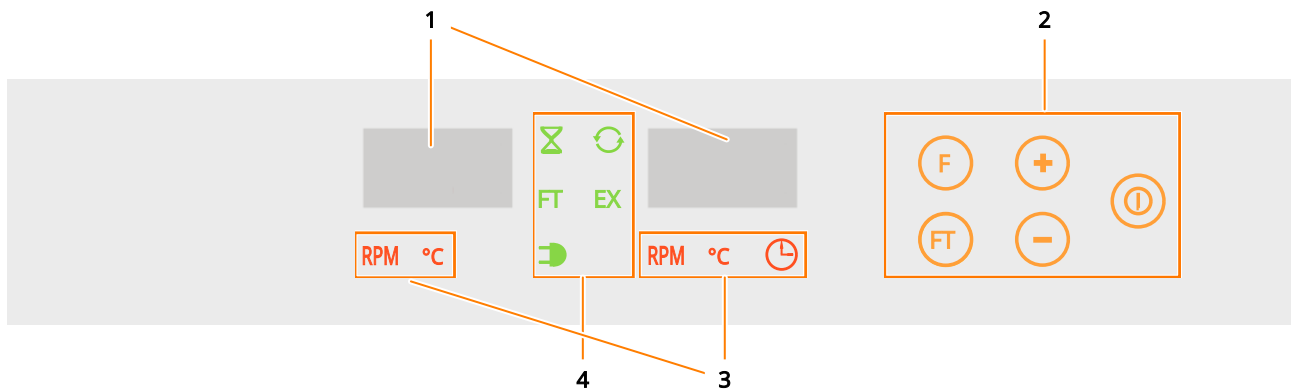

- 1 View boxes for actual values, setpoints, alarm messages and error messages
- 2 Function buttons for entering parameter values (orange)
- 3 Parameter symbols (red)
- 4 Function symbols (green)

For more information on the display and operating elements on the operating panel, see → Chapter 3.6.1 'Operating and Display Elements' on page 30.

3.7 Markings on the Device

3.7.1 Identification Plate

Position

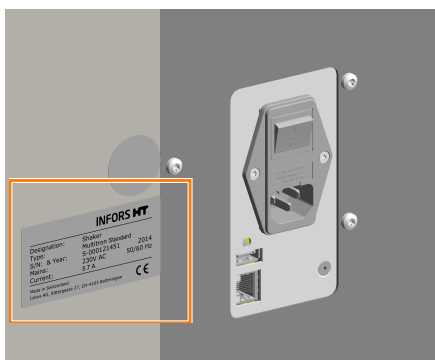

Das Typenschild zur Identifikation des Geräts befindet sich auf der linken Seite des Geräts im Bereich des Netzanschlusses. Ein zweites Typenschild befindet sich im unteren Bereich der Tür.

Setup and Function

Content

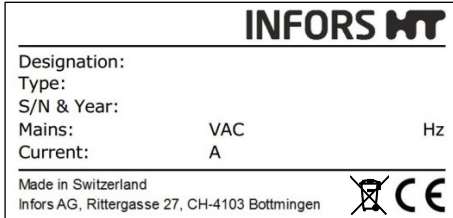

The identification plate is designed to allow clear identification of the device. It contains the following information:

- Manufacturer's name
- Designation = category of device
- Type = device type (name)
- S/N = serial number
- Year = year of manufacture
- Mains = nominal voltage and frequency
- Current = power consumption
- Manufacturer's address
- WEEE marking
- CE marking

3.7.2 Identification of the Throw

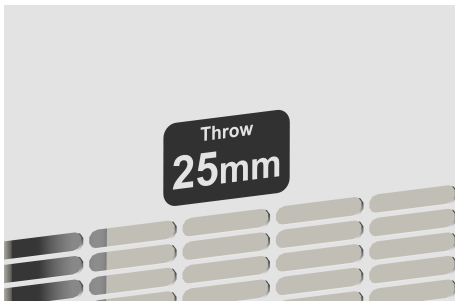

On the back wall inside the incubation chamber, there is a sticker that identifies the throw (*Throw*).

4 Accessories

The following chapters describe all accessories that are generally available for the device. For special applications, our customer service is available for consultation.



Detailed information and order details for our accessories can be found in our accessories catalogue. This can be obtained from INFORS HT or your local licensed dealer.

4.1 Trays



Different trays are available for the device; these can be purchased individually or ordered with the device.

In addition to the universal table tray, which can be equipped as desired, various trays with fixed features are available for different purposes. Pre-fitted trays are equipped with one clamp type each. They are used if only a single size of flask is to be used for certain tasks. In contrast to the universal table tray, their holders cannot be changed. Pre-fitted trays feature a capacity that is up to 20% higher than an individually equipped universal table tray. Since no drill holes have to be taken into account in the grid, the clamps can be installed closer together.

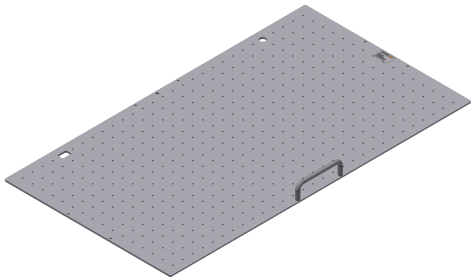
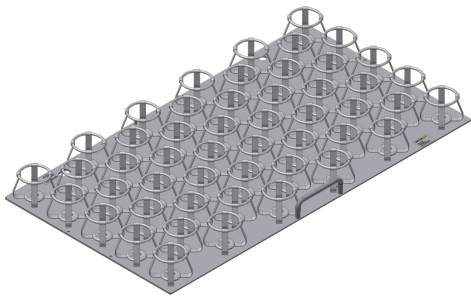
The following trays are available:

Figure	Designation
	Universal table tray
	Tray with steel clamps

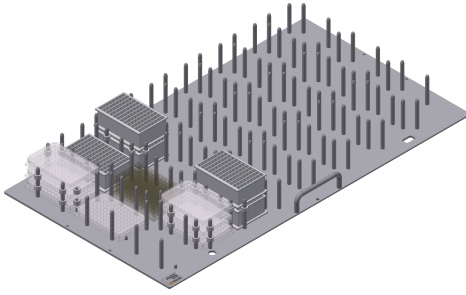
Accessories

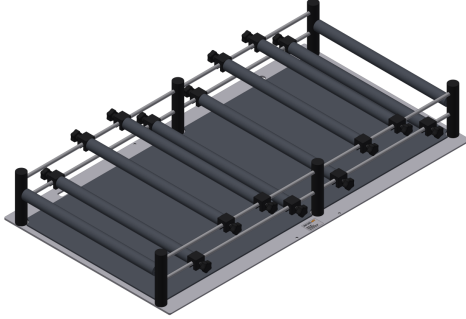
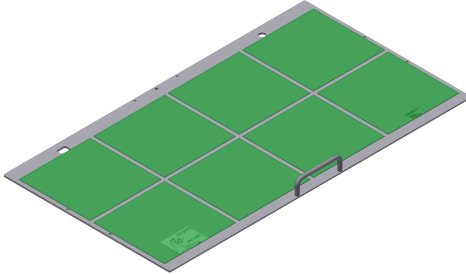
Figure	Designation
	<p>Tray with pin holders for microtitre and deep-well plates</p>
	<p>Tray with clamping assembly for microtitre and deep-well plates</p>
	<p>Tray with sliding bars</p>
	<p>Tray with Sticky Stuff</p>

4.1.1 Universal Table Tray

Overview

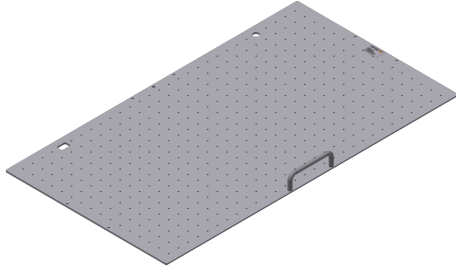

The tray referred to as “universal table tray” features drill holes on a grid so that it can be equipped as desired. For equipping, various clamps and test tube holders are available; these can be combined as desired (➔ Chapter 4.2 ‘Clamps and Other Holders’ on page 999).

The universal table tray is made of anodised aluminium and can be sterilised in the autoclave if required.

The separately available Sticky Stuff adhesive matting can also be stuck onto the universal table tray.

Technical Data

Data	Value
Material	Aluminium
Size	850 x 470 mm
Weight	4.5 kg
Threaded holes	M4
Threaded holes	462
Threaded hole grid	28.28 x 28.28 mm
Sterilisation in an autoclave	YES

Accessories

4.1.2 Tray with Steel Clamps

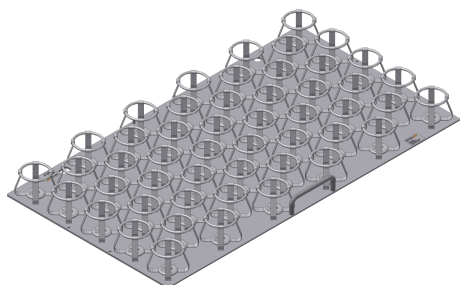

Fitting identical clamps on the entire tray results in the following capacities:

Flask size [mL]	Number of flasks per M tray
25	197
50	131
100	91
250	48
500	31
1000	19
2000	13
3000	9
4000	8
5000	6

4.1.3 Tray with Pin Holders

Overview

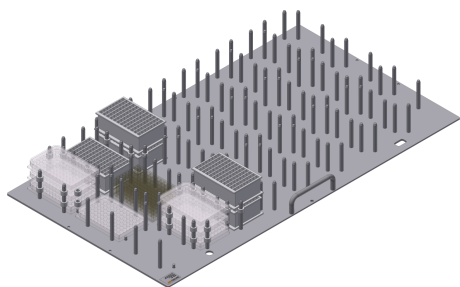

For applications in which large numbers of microtitre or deep-well plates need to be incubated, various trays with pin holders are available. These enable loading with several layers of microtitre and deep-well plates.

The plates can be stacked. This allows you to simultaneously incubate up to 72 deep-well plates and up to 144 microtitre plates on one M tray.

The trays are designed for plates with the dimensions 85.1 x 127 mm.

To ensure the cultures receive the optimum oxygen supply, spacers can be placed between stacked plates. It is available in two variants:

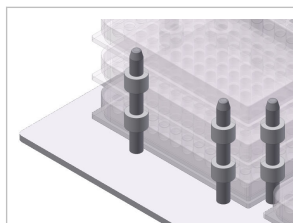

Ring spacers (10 mm high) are placed on the pins individually. Depending on the type of tray loading, this makes it possible to remove individual plates or stacks of plates.

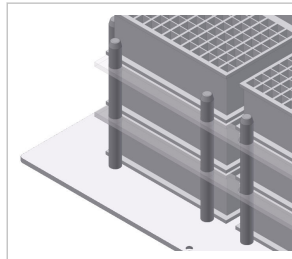

Quickload spacers are long plastic strips (4 mm high) that span across several plates, thus allowing you to save time while loading.

! NOTICE

The spacers are made of plastic and therefore cannot be autoclaved.

Technical Data

Data	Value
Material	Aluminium
Fastening screws	M5 x 12
Cleaning	Mild neutral cleaning agent
Disinfection	Commercially available disinfectant
Sterilisation in an autoclave	YES
External dimensions of the microtitre plates	85.1 x 127 mm
Height of the deep-well plates	42 mm

4.1.4 Tray with Clamping Assembly

Overview



To affix microtitre and deep-well plates, there is a quick clamping assembly. Two versions of this clamping assembly are available:

Tray with flat clamping assembly (horizontal incubation): The flat clamping assembly is a profile made of sheet metal that is equipped with an angled strip (2). On the other side, there is an edge featuring a foam rubber strip (3). There are two spacers on the edge (1) for positioning microtitre plates or deep-well plates.

Accessories

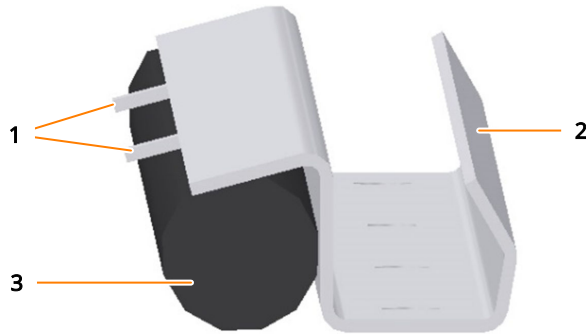

Tray with clamping assemblies tilted at an angle of 20° (angled incubation): The folded clamping assembly is wedge-shaped metal sheet with two profiles. The lower profile is an angled bar (3). The upper profile is a U profile into which the cellular rubber string (2) is inserted. There are two spacers on the upper edge (1) for positioning the microtitre plates or deep-well plates.

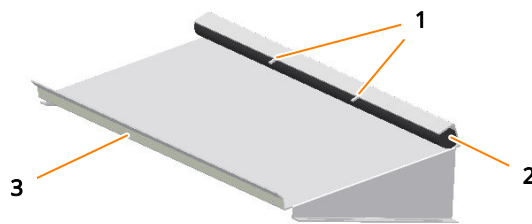

The trays with clamping assemblies are designed for microtitre and deep-well plates with dimensions 85.1 mm x 127 mm. To ensure sufficient clamping force can be achieved, plates with a web height of at least 3 mm must be used.

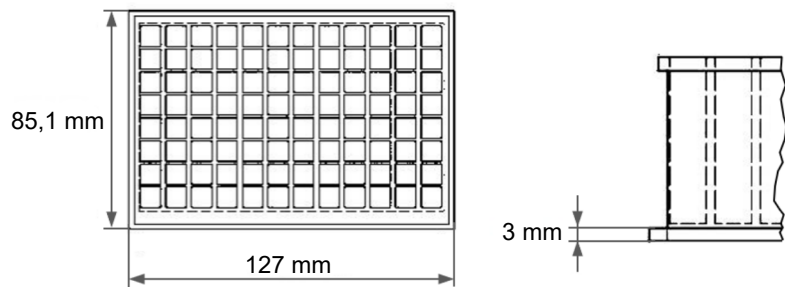

Technical Data

Data	Value
Rail material	Aluminium
Foam rubber material	CR rubber
Temperature range	≤ 80°C
Cleaning	Mild neutral cleaning agent
Disinfection	Commercially available disinfectant
Sterilisation in an autoclave	NO
Size of microtitre plates/deep-well plates	85.1 x 127 mm

4.1.5 Tray with Sliding Bars

Overview

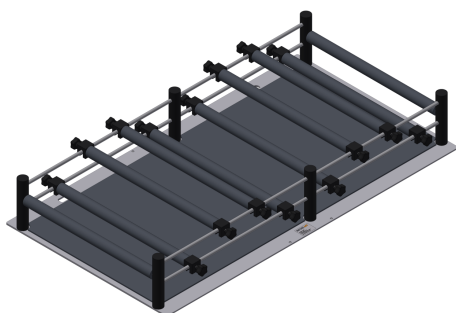

Trays with sliding bars enable the affixing of vessels of various shapes and sizes. The sliding bars can be affixed to any point on the support bars. This also allows you to affix bottles with vertical walls and a curved base.

The bars enveloped in soft material are arranged on two different levels to securely hold bottles of different sizes.

The scope of delivery for the tray includes the fixed mounted frame and 8 movable sliding bars.

Technical Data

Data	Value
Material	Aluminium, plastic
Cellular rubber mat	EPDM cellular rubber
Cellular rubber cover	Armaflex
Cleaning	Mild neutral cleaning agent
Disinfection	Commercially available disinfectant
At operating temperature	65 °C
Sterilisation in an autoclave	NO

Accessories

4.1.6 Tray with Sticky Stuff

! NOTICE

If condensate forms on the tray or the culture vessels, the adhesiveness of the Sticky Stuff adhesive matting is no longer guaranteed. This can result in cultivation vessels separating from the adhesive matting and breaking.

Hence, consider the following when using Sticky Stuff:

- Ensure that condensate does not form on the tray or the culture vessels. This is particularly necessary when cultivation is started at low temperatures and the temperature is then increased.
 - Let cultivation vessels that were stored in the fridge warm up to ambient temperature first before placing them on the adhesive matting.
- If you are looking for a very flexible option for equipping the tray, the tray with Sticky Stuff offers an ideal alternative.
 - However, you have to keep in mind that rotation speeds are limited when using Sticky Stuff (for more information on this, refer to the table at the end of the chapter).

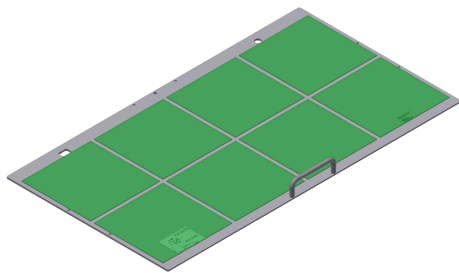

Due to limited resistance to disinfectants as well as the risk of unintentional detaching of flasks, Sticky Stuff is not suitable for cultivating pathogenic microorganisms.

Using Sticky Stuff

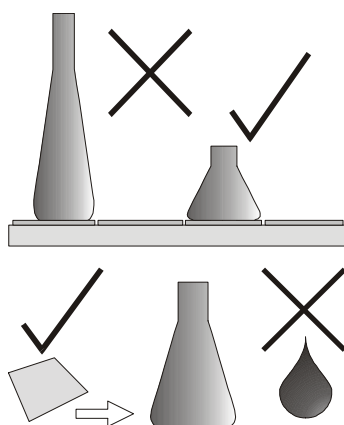

- Use only vessels with a broad flat base. Large Erlenmeyer flasks (e.g. 3000 mL) adhere more strongly than smaller ones (e. g. 500 mL).
 - Ensure that the entire bases of the flasks are on the adhesive matting. They must not extend beyond the edge of the tray.
- Check vessels for damage prior to use and replace, if necessary. Never use damaged vessels!
 - Prior to putting down any vessel, ensure that its base is dry, clean and grease-free.

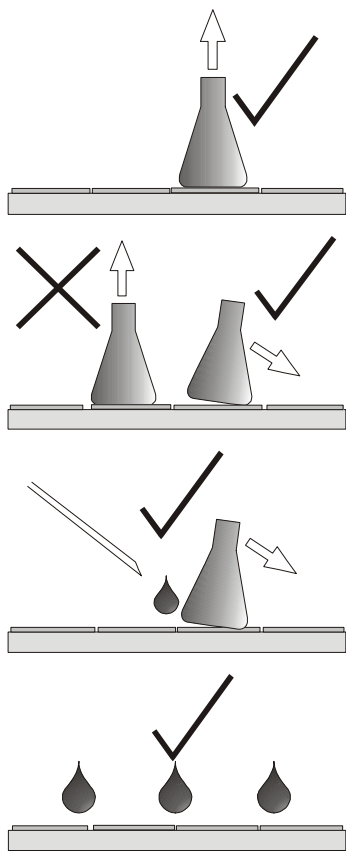

- Prior to the shaking process, gently pull on every vessel to ensure they are all stuck on firmly.
- If the humidity is too high or the temperatures are too low or if there are extreme jumps in temperature (e.g. when using the timer function), keep an eye on condensate. Condensate can result in vessels detaching from the adhesive matting.
- To remove vessels, gently and evenly pull or push on the neck and wait a few seconds.
Never apply force!
- In case of large vessels, it can take 20 to 30 seconds until they detach from the adhesive matting.
- Vessels that are stuck can be removed from the adhesive matting by using a syringe to inject water under the flask.
- Due to their shape (wide base, short neck), Fernbach flasks in particular can be difficult to remove. If necessary, cover part of the adhesive matting with the protective foil provided.
- The adhesive power can deteriorate over time due to dust and dirt. To clean and restore full adhesive power, thoroughly wipe down the surfaces with a brush or a dish sponge and clear water with mild detergent (dishwashing liquid). Then allow to dry overnight.
- Quaternary ammonium compounds are suitable for disinfection.
- Note the application time and rinse thoroughly with water afterwards. If the adhesive matting is disinfected at regular intervals, it might need to be replaced sooner.

Replacing the Adhesive Matting

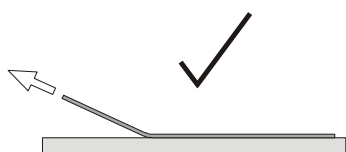

To replace the adhesive matting proceed as follows:

- 1.** Thoroughly moisten the tray with water.
- 2.** Release the adhesive matting on one side of the tray and then pull upwards at an angle.
- 3.** Degrease the tray with acetone and apply new wet adhesive matting (as per separate installation instructions). Only remove protective foil prior to use.
 - The removed adhesive matting can be reused and can be reapplied after regeneration in water.

Accessories

Service Life

Sticky Stuff is a consumable that typically has to be replaced every 2 to 5 years. The service life depends on how the material is used and cleaned. If you are regularly using aggressive chemicals to clean or disinfect, we recommend replacing the Sticky Stuff every 2 years.

! NOTICE

Normal ageing and/or use of aggressive chemicals reduces the adhesiveness. This can result in vessels coming loose and thus damaging the device.

- Replace severely worn adhesive matting.
- Only use absolutely clean, dry and grease-free adhesive matting.
- Check the adhesiveness prior to use. If you are unsure, slowly increase the rotation speed and check that the vessels adhere safely.

Suitable/Unsuitable Vessels

Sticky Stuff is suitable for use in combination with the following vessels:

- Erlenmeyer or Fernbach flasks made from glass or polycarbonate with a smooth bottom and without crowning

When using unsuitable vessels, the adhesive power is reduced significantly. If unsuitable vessels are used in combination with Sticky Stuff, it is the user's responsibility to check if the adhesiveness suffices. In addition, only reduced rotation speeds are possible when using unsuitable vessels. Unsuitable vessels include, for example:

- High and narrow vessels
- Bottles
- Erlenmeyer flasks with crowning and correspondingly reduced contact area

Maximum Rotation Speeds with Sticky Stuff

To ensure that the flasks do not detach from the adhesive matting, the maximum permissible rotation speed is limited when using adhesive matting.



The following guidelines only apply to undamaged, completely dry adhesive matting and flasks free of grease. If old or dirty adhesive matting is used, there is a risk that flasks detach even at lower rotation speeds.

Schott Duran® glass Erlenmeyer flask	Filling	Maximum permissible rotation speed	
		25 mm throw	50 mm throw
25 to 750 mL	20 %	250 min ⁻¹	200 min ⁻¹
1000 mL	20 %	300 min ⁻¹	250 min ⁻¹
2000 mL	20 %	300 min ⁻¹	250 min ⁻¹
3000 mL	20 %	350 min ⁻¹	300 min ⁻¹
5000 mL	20 %	300 min ⁻¹	250 min ⁻¹

Corning plastic Erlenmeyer flask	Filling	Maximum permissible rotation speed	
		25 mm throw	50 mm throw
125 to 3000 mL	20 %	300 min ⁻¹	200 min ⁻¹

Corning plastic Fernbach flask	Filling	Maximum permissible rotation speed	
		25 mm throw	50 mm throw
3000 mL	20 %	300 min ⁻¹	250 min ⁻¹

4.2 Clamps and Other Holders

For individual fitting of the universal table tray, various clamps and holders are available.

4.2.1 Clamps

For fitting a universal table tray, clamps of various sizes are available. These can be ordered individually and mounted on the universal table tray.

Accessories

Stainless Steel Clamps



The following stainless steel clamps are available:

For flask type	Volume, mL
Erlenmeyer	25, 50, 100, 250, 500, 1000, 2000, 3000, 4000, 5000
Fernbach	1800, 2800
Thomson Optimum Growth®	7000

Data	Value
Material	Stainless steel
Fastening screws	25 to 50 mL: M4 x 6 100 to 7000 mL: M4 x 8
Temperature range	95 °C
Cleaning	Mild neutral cleaning agent
Disinfection	Commercially available disinfectant
Sterilisation in an autoclave	YES

Plastic Clamps

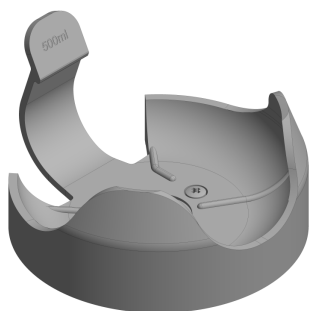

The following plastic clamps are available:

For flask type	Volume, mL
Erlenmeyer	100, 500

Data	Value
Material	POM Co polymer
Fastening screws	M4 x 6
Temperature range	65 °C
Cleaning	Mild neutral cleaning agent
Disinfection	Commercially available disinfectant
Sterilisation in an autoclave	NO

4.2.2 Test Tube Holder



Test tube holders are used to securely affix different sized test tubes. Test tube holders can be screwed onto a universal table tray or placed on Sticky Stuff adhesive matting.

The following test tube holders are available (details and special variants on request):

- For long test tubes; Ø 8 to 30 mm
- For short test tubes; Ø 12 to 18 mm
- For plastic tubes with ventilation lid; Ø 16 and 30 mm
- Special holders, e. g. for 600 mL culture vessel

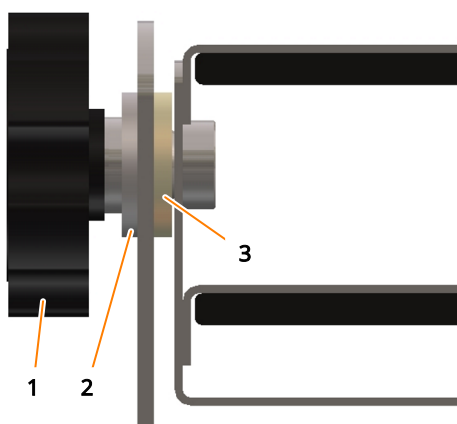

If necessary, the inserts with the tubes can be tilted by loosening the black nuts (1). The tilt can be set freely. Then tighten the nuts again.

The entire inner part with the holders for the tubes can be removed by loosening the black nuts, whereby the u-shaped holder remains on the tray.

When inserting the inner parts, ensure that the feet of the holder (part on the tray) on both sides rest between the rubber ring (3) and the Teflon washer (2).

Test tube holders can also be used on a tray with Sticky Stuff. To do this, the pre-installed screw must be removed from the base plate.

! NOTICE

The test tube holders adhere extremely strongly to the Sticky Stuff so that water has to be sprayed underneath the edge of the holder with a syringe in order to remove them. This is done to prevent damage to the holder or the tray.

4.3 Box for Microtitre Plates

Overview



The box for microtitre plates is used for low-vapour cultivation of microtitre plates and deep-well plates. It protects cultures from drafts in the incubation chamber and also offers a stable container in which cultures can be transported.

The box for microtitre plates consists of an aluminium container with a removable lid into which a replaceable paper filter is integrated. A microtitre insert with screw-mounted pins is used for mounting microtitre plates and deep-well plates.

For shaking, the box for microtitre plates can be screwed onto a universal table tray or placed on the Sticky Stuff adhesive matting.

Accessories

Setup

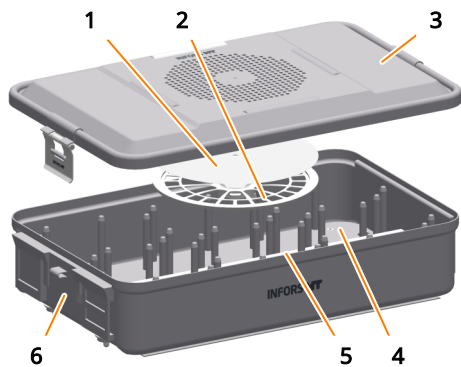

- 1 Filter
- 2 Filter washer
- 3 Top plate
- 4 Microtitre insert
- 5 Quickload spacers
- 6 Container

Installation

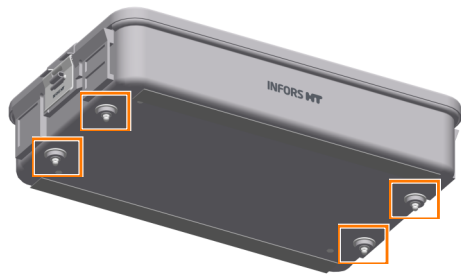

The box for microtitre plates is affixed to the tray with four Philips head screws. When delivered, the fastening screws are covered with plastic cap nuts. These must be removed prior to installation.

Alternatively, the box for microtitre plates can be placed on the Sticky Stuff adhesive matting. In this case, all fastening screws must be removed to avoid damaging the adhesive matting.

During installation, ensure that the tray is always loaded evenly.

Loading

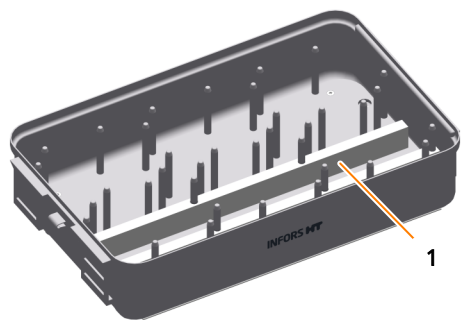

To improve transfer of oxygen to the cultures and facilitate the removal of the plates, spacers (Quickload Spacers) (1) can be placed between the individual layers. Prior to loading, the Quickload Spacers must be removed. Following that, microtitre or deep-well plates can be inserted.

For cultivations with a low oxygen requirements, Quickload Spacers do not have to be used.

Inserting/Replacing a Filter

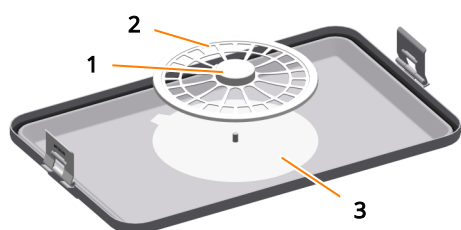

To insert or replace a sterile filter (3) the filter washer (2) must be removed first. To do so, press the locking button (1) on the filter washer and lift up the filter washer. Following that, the filter can be inserted and the filter washer can be put back in its place.

Sterilising

The box for microtitre plates can be autoclaved (recommendation: 20 min at 120 °C). To do so, remove the Quickload Spacers first and disinfect them using commercial disinfectant.

Limiting the Rotation Speed

When there are high rotation speeds or insufficient grip due to humidity or dirt, the box for microtitre plates can separate from the Sticky Stuff and cause damage to the incubation chamber. The maximum permissible rotation speed is therefore limited as follows:

Tray	25 mm throw	50 mm throw
On universal table tray	350 min ⁻¹	250 min ⁻¹
On Sticky Stuff	150 min ⁻¹	150 min ⁻¹

Technical Data for Container with Top Plate and Tray

Data	Value
Dimensions	465 x 280 mm
Weight	4.23 kg
Filter, paper, round, Ø	185 mm
Screws for microtitre tray	M4 x 8 hexalobular
Screws for microtitre box	M4 x 12 Phillips head
Material	Aluminium, autoclavable
Detergent	Mild dishwashing liquid or neutral cleaning agent

Technical Data of the Quickload Spacer

Data	Value
Dimensions	412 x 14 x 5 mm
Quantity	12 units
Material	Polyamide 6.6 can be sterilised
Detergent	Mild dishwashing liquid or neutral cleaning agent

Accessories

Loading Capacity

Data	Value
Microtitre plates	18 units
Deep-well plates, height 42 mm	12 units



Valid for standard plate size 85.1 x 127 mm.

4.4 eve®



eve® is a platform software for planning, execution and analysis of bioprocesses. eve® makes it possible, for example, to record bioprocess data and store it in a central database. The software offers workflows from simple bioprocesses to the planning and execution of complex strategies with various process phases.

eve® makes it possible to generate and store bioprocess knowledge. For example, various libraries for storing information on organisms and culture media are available. Thanks to soft-sensors, additional knowledge can be generated.

In addition to INFORS HT products, biotech machines and analysis devices from third-part manufacturers can be connected. This makes it possible to holistically control, monitor and analyse bioprocesses using a software.

eve® is installed on a centralised server. Access takes place via a browser, no client side installation is required. Bioprocess data is therefore available directly via the browser and independent of the operating system.

Various packages of the software are available. This makes it possible to adapt it to the individual needs and requirements of its users.

eve® (the premium version) is also suitable for working in a validated environment as per FDA CFR 21 Part 11.

Installation and Commissioning

5 Installation and Commissioning

Only the manufacturer’s qualified expert personnel or persons authorised by the manufacturer may install and initially commission the device. Hence, the following section only lists the requirements for the installation location to be observed by the provider.

WARNING

Installation and initial commissioning require trained expert personnel with sufficient experience. Errors during installation may lead to dangerous situations or significant damage to property.

- Only the manufacturer’s expert personnel or persons authorized by the manufacturer may install and initially commission the device.
- Contact the manufacturer if the device is to be placed in a different location.

5.1 Operating Conditions at the Installation Location

Operating Conditions

To achieve optimal and reproducible results, the device should be set up in stable ambient conditions without significant temperature and humidity fluctuations. Changes in ambient temperature and humidity (even short-term) can have a negative impact on the climate in the incubation chamber.

Temperature range	10 °C to 30 °C
Humidity	10 % to 85 %
Restrictions	<ul style="list-style-type: none"> ■ Do not expose to direct sunlight ■ Do not expose to dust ■ Do not expose to vibrations

The device may only be set up indoors.

Installation and Commissioning

Unsuitable Installation Sites

In order to achieve the desired climate in the incubation chamber and to be able to control it as precisely as possible, the following installation locations must be avoided at all costs:

- Poorly ventilated recesses or areas in the exhaust heat air stream of air conditioners or other sources of heat
- Directly underneath, next to or in the air stream of the air conditioners or other devices that generate strong air flows (e.g. circulation fans in clean rooms)
- Directly next to device with strong heat radiation, such as heaters or autoclaves, or in their exhaust heat stream
- Directly next to refrigeration devices, such as deep freezers or refrigerated centrifuges, or in their exhaust heat air stream



To be able to achieve the desired temperature in the incubation chamber, the ambient temperature directly at the device is decisive. This can be considerably higher than the temperature at other positions in the room due to the waste heat of the unit or due to other devices with strong heat radiation in the immediate vicinity!

5.2 Requirements for the Mains Connection

To avoid dangers due to electrical current, the in-house mains connection must meet the following requirements:

- Constant power supply
- Recommendation: in the building, secure the power supply using a fault current protection switch (RCD – Residual Current Device).

In addition to that, ensure the following:

- The voltage values of the device match those of the local mains voltage. Note the information on the identification plate.
- Use the power cable provided. If the power cable becomes defective, replace it with a power cable of the same type.
- The mains connection can be accessed at all times.

Refer to the technical data for the electric connection values.

5.3 Minimum Distances to the Device

When setting up the device, the following minimum distances must be observed to ensure adequate ventilation and access to the most important connections:

Minimum Distances to the Basic Unit

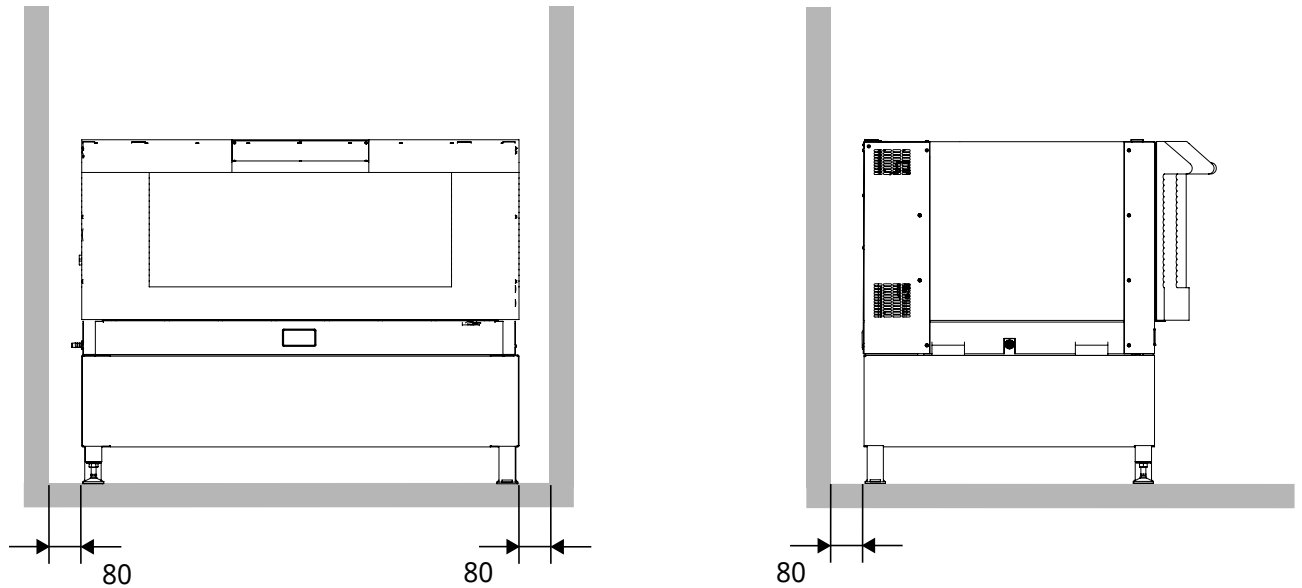

Device on a Bench

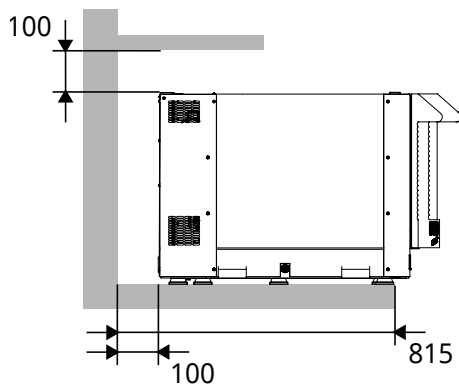

When placing the device on a bench, observe the following:

- To prevent the bench from vibrating, use a heavy bench with diagonal braces as the minimum (ideally, use a stable laboratory bench). Alternatively, the bench can be affixed to the wall.
- The minimum required depth for the bench is 815 mm.
- You must leave a ventilation gap of at least 100 mm between the device and rear wall.
- If shelves or cupboards are mounted above the bench, you must leave a minimum distance of 100 mm.
- No gas outlets, shelves or cupboards must be in the way.

Installation and Commissioning

Device under a Bench

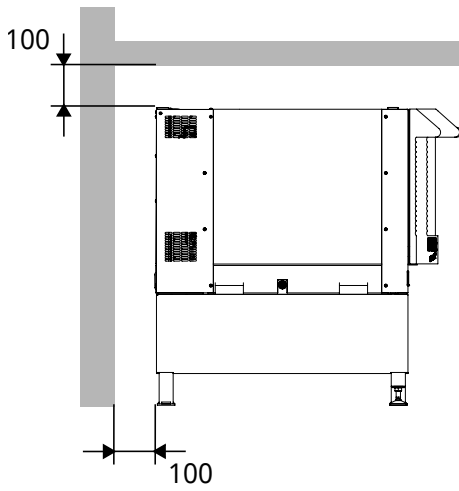

When placing the device under a bench, observe the following:

- You must leave a ventilation gap of at least 100 mm between the device and rear wall of the bench to ensure that heat produced by the device can escape.
- The minimum distance between the device and the underside of the bench top is 100 mm.

! NOTICE

Failure to comply with the required minimum distances can result in components of the device overheating and the device being damaged. As such, please observe the following points:

- Never cover the air vents on the right-hand side or those on the rear of the device.
- Never position the device right up against a wall.

6 Operation

6.1 Switching the Device on

NOTICE

The shaker drive can start up automatically, if the device was not switched off correctly beforehand. Lose items in the incubation chamber can damage the device and cultivation vessels if this happens.

- ➔ Activate the power switch on the right side of the housing.
 - ➔ Once it has been switched on, the device will automatically run a self-test. The view boxes display the message *HELLO*. If the device was not switched off correctly (parameters still activated), the message *P. out* then appears. This message can be cleared by clicking any button.
 - ➔ Once the initialisation process is complete, the *Power supply on/off* function symbol will light up briefly. The device is then ready for operation.



6.2 Loading the Device

CAUTION

If a vessel breaks at high rotation speed, the glass splinters are slung around the interior. When the door is open, the device does not halt immediately so pieces of glass can be slung out.

- Do not open the door in a panic if you notice that a vessel has broken.
- Switch off the device at the power switch and only open the door when the table stands still.

CAUTION

If you put a load of more than 20 kg on the door of the device, there is a risk that the door might break. This can lead to property damage and injuries.

- Do not lean on the door.
- Do not put a load of more than 20 kg on the door.

Operation

6.2.1 Opening the Door

The door can be opened while the device is running. The table and temperature control are stopped as soon as the door is opened more than 30°. It is not possible to open the door fully until the table has come to a full stop. The table will start up again automatically as soon as the door is closed more than 45°.

CAUTION



If the door is opened while the shaker drive is running, the table can cause injury due to its significant momentum. As such, take care when opening the door while the shaker drive is running, and wait until the table has come to a complete standstill.

NOTICE

The door can only be opened fully when the device is switched on at the power switch and there is no load on the half-open door. If the door is pushed down violently, this can damage the door mechanism.

Under no circumstances leave the door hanging halfway in the lock. Support the door by hand until the table has come to a complete stop and the door lock is heard to unlock.

In order to open the door while the shaker drive is running, proceed as follows:

1.  Temporarily stop the device by slightly opening the door.
2.  Wait until the table has come to a standstill.
 - ➔ The door is unlocked and remains unlocked for five seconds.
3.  Open the device door all the way. If the door does not unlock straight away, do not lean on it; instead, lift it up slightly to take the load off the locking mechanism. If the door is not opened within five seconds, it is locked again and must be fully closed and opened again.

6.2.2 Inserting and Removing the Tray

Tray Lock Overview

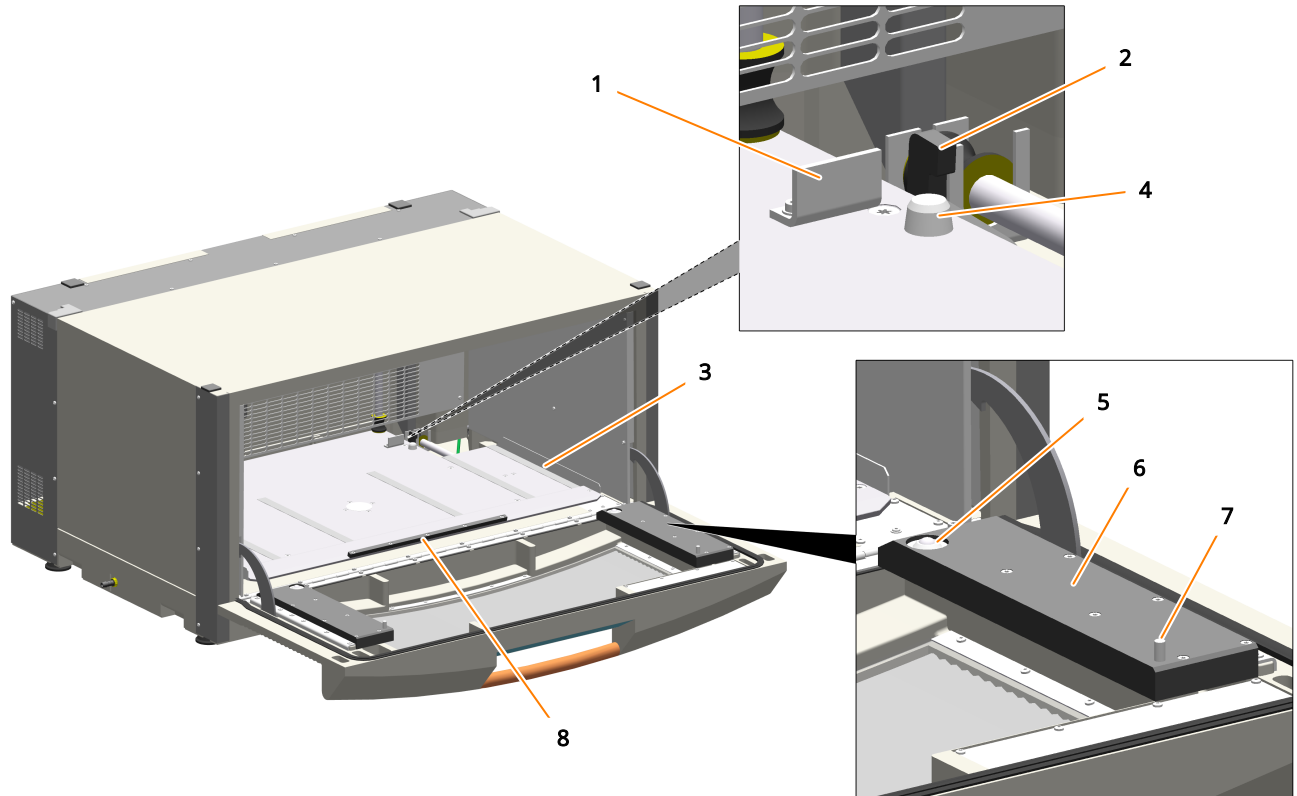

- 1 Limit stop
- 2 Lock hook
- 3 Guide rail
- 4 Locking cone

- 5 Cylindrical ball caster
- 6 Slide rail
- 7 Screw-mounted pin
- 8 Stop bar



The device is fitted with a tray lock to hold the tray securely in place on the table. When the door is opened fully, the lock hooks (2) on the table release the tray. The tray ejectors underneath the table lift the tray out of the locking cones (4) on the table. The tray is now free and can be pulled out of the incubation chamber by hand.

The tray is removed from the incubation chamber using slide rails (6) and the cylindrical ball casters (5) inside them which are located on the inside of the door. Two screw-mounted pins (7) in the slide rails limit how far the tray can be pulled out. When pulled out all the way, the tray lies partially on the door and partially on the table.

Operation

Removing the Tray

To remove the tray, proceed as follows:







1.  Open the device door all the way.
 - ➔ The safety mechanism unlocks the lock hooks (2) automatically when the door is opened, and lifts the tray out of the rear cones (4).
2.  Lift the tray by the handle and pull it onto the open door.



If you cannot pull the tray out, check whether the door is open all the way. Push the door down as far as it will go.

Inserting the Tray

The insertion of the tray works independently of the position of the table. Proceed as follows:

1.  Open the device door all the way.
2.  Place the tray on the slide rails of the doors (6).
3.  Push the tray between the guide rails (3) up to the limit stop (1) in the incubation chamber.
4.  Check whether the tray is placed properly behind the front stop bar (8).
5.  Close the device door.
 - ➔ When the door closes, the ejection levers lower and the tray is lowered into the two cones (4). At the same time, the lock hooks (2) move forwards to secure the tray to the table.
6.  Check whether the lock hooks hold the tray in place securely when closing the door.

NOTICE

If the tray is not held in place securely on the table, the tray's movement may damage the interior of the device.

- Do not start up the device unless the tray has been inserted correctly and affixed securely.



If you are unable to insert the tray correctly, perform the following checks:

- Remove the tray and check it is not twisted or bent.
- Check the incubation chamber for foreign objects and remove these.
- If it is still not possible to insert the tray correctly, contact your nearest INFORS HT representative.

6.2.3 Mounting the Holders

! NOTICE

The threaded holes of the tray can be damaged if the fastening screws are not screwed straight into the thread.

- Place the screws vertically on the drill holes.
- Ensure they can be tightened easily.

! NOTICE

All holders are supplied with pre-fitted screws. If a test tube holder or box for microtitre plates is placed on the Sticky Stuff adhesive matting, there is a risk that the adhesive matting is damaged by protruding screws.

Remove the screws before you place test tube holders or microtitre plates on the Sticky Stuff adhesive matting.

Operation

Mounting a Holder

Clamps, test tube holders and boxes for microtitre plates are fixed to the tray using screws. The device is delivered with pre-fitted screws. The screws are each secured with one flat gasket at the bottom so that they cannot fall out. Only use the screws provided or screws of the same size for mounting.

To mount a holder, proceed as follows:

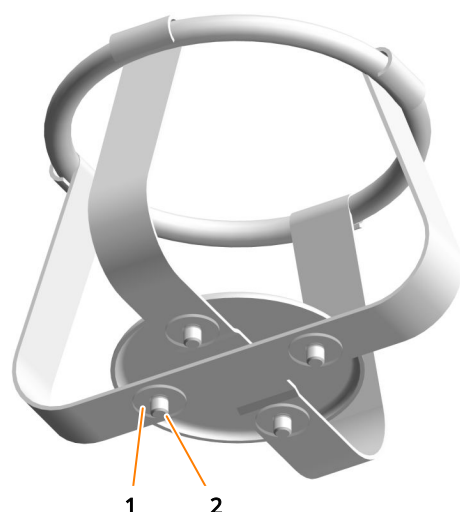

1. ➤ Loosen the flat gaskets (1).
2. ➤ Position the holder on the tray.
3. ➤ Centre a screw (2) on the threaded hole in the tray and screw it in loosely. It must still be possible to turn the holder.
4. ➤ Align the holder so that all screws are vertical above the respective threaded hole in the tray.
5. ➤ Insert the screws loosely. Ensure that the screws are screwed in straight and do not tilt.
6. ➤ Evenly tighten all screws cross-wise.

Screw Sizes

! NOTICE

If screws that are too long are used to install the holders, these will stick out at the bottom of the tray. This has the effect that the tray can no longer be inserted and affixed correctly.

If you have to replace lost fastening screws, you must use screws that comply with the specification below.

Holder	Size	Screw	Flat gasket
Steel clamps	< 100 mL	Flat head screw with Phillips head M4 x 6 A4	D = 3.2 x 12 x 0.5
	≥ 100 mL	Flat head screw with Phillips head M4 x 8 A4	D = 3.2 x 12 x 0.5
Plastic clamps	100 to 500 mL	Flat head screw with Phillips head M4 x 6 A4	D = 3.2 x 12 x 0.5
Test tube holder	Ø 8 to 30 mm	Oval head screw with Phillips head M4 x 6 A2	D = 3.2 x 12 x 0.5
Boxes for microtitre plates	n. a.	Oval head screw with Phillips head M4 x 12 A2	D = 3.2 x 12 x 0.5

6.2.4 Tips & Tricks for Loading the Tray

Observe the following notices when loading the tray:

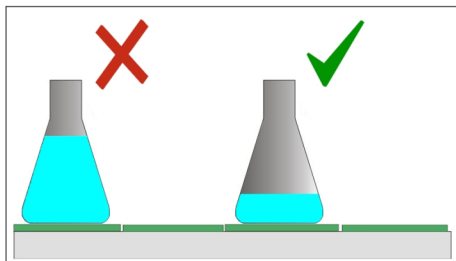

- The working volume should not exceed 1/3 of the total volume of the vessel.

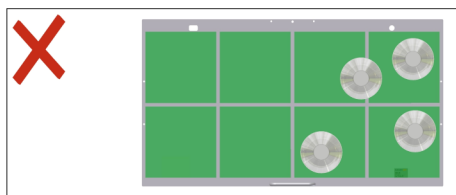

- To ensure smooth operation, place the cultivation flasks symmetrically in the middle of the tray. Do not place heavy vessels at the edge of the tray.

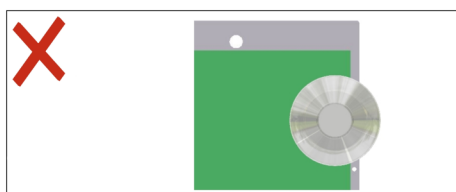
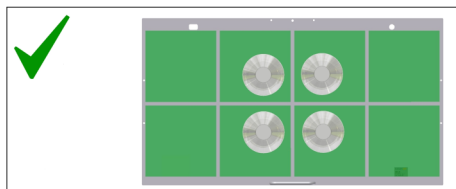

- If the flasks extend beyond the edge of the tray, they may be damaged or broken if they collide with the wall of the device. Therefore, always position cultivation vessels on the tray so that they do not protrude.

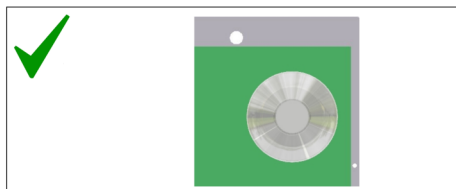

- If the tray is only loaded lightly and is going to be run at high rotation speeds, place additional cultivation vessels filled with water on the tray. This will make the device run smoothly.

At shaker speeds of approx. 200 min⁻¹ to 250 min⁻¹ (depending on the throw and the position of stacked device units), the load distribution plays only a minor role.

CAUTION

If the loading mass of the table is too high or too low or the load is distributed unevenly, high rotation speeds can cause vibrations. This can result in the device moving uncontrollably.

- Never operate the device without a tray and loading.
- In case of strong vibrations, reduce the rotation speed and check the loading weights or the distribution of the load.

Operation

6.3 Setting, Activating and Deactivating Parameters

Setting the Setpoint and Switching on the Parameter



The parameter that can be set is always displayed in the right view box (1).

To set the setpoint for a parameter and switch on the parameter, proceed as follows:

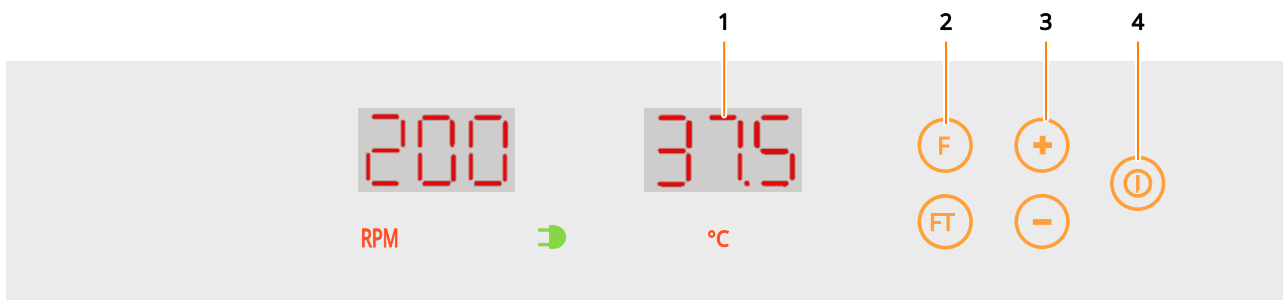

1. → Press the **F** button (2) to select the parameter in question.
 - ➔ The right display (1) shows either the current actual value of the parameter or alternately the setpoint and the message *OFF*.
2. → Press the **Plus** or **Minus** button (3) to set the setpoint you want to use for the selected parameter. You can scroll through value range in steps of ten by holding the **Plus** or **Minus** button down.
 - ➔ The entered value is saved automatically. A separate confirmation is not necessary. If the parameter is already activated, the changes take effect immediately.
3. → To switch on the parameter, press the **On/Off** button (4).
 - ➔ The parameter is activated immediately.
 - ➔ The display briefly shows the message *on* and then the current actual value.



When starting up the shaker drive, use the time until the setpoint is reached to check whether the cultivation flasks are secured on the tray.



The parameters need a little time to reach their set setpoints. Until they have done so, the messages *Hi* or *Lo* is displayed, depending on whether the actual value is higher or lower than the setpoint.

Deactivating Parameters

The parameters are deactivated using the same procedure as for activation. Select the parameter you wish to deactivate using the **F** button, then press the **On/Off** button to deactivate it. When a parameter is deactivated, the display alternates between the set setpoint and the message *OFF*.

6.4 Timer Function

6.4.1 Overview

NOTICE

If cultivation is started at low temperatures and the temperature is then increased (e.g. when using the timer), condensation can form on the flasks because these are heated up slower than the ambient air. When using the device in conjunction with the Sticky Stuff adhesive matting, this can lead to the flasks coming off the adhesive matting.

The timer function can be used to set defined sequences. For example, the parameter setpoints can be changed after a certain time or the starting of the cultivation can be delayed. The timer can be programmed in two different modes:

- One-time change from phase 1 to 2
- Cyclical changing between phases 1 and 2



More complex sequences or processes can be programmed using the eve® bioprocess platform software.

The following rules are important for understanding the timer function:

- The **F** button is always used to set the current parameters.
- The **FT** button is always used to set the parameters that will apply for the next phase.
- The device is always in phase "F". The "FT" values simply define what will happen at the next change.

Operation

One-Time Change from Phase 1 to 2

If the device is programmed this way, the setpoint settings for the cultivation process parameters will change when the specified time expires. The device will then keep running using the setpoints specified for the second phase until the device is stopped by deactivating the parameters.

Example applications:

- Starting the cultivation process on a time delay
- Induction of a protein expression
- Stopping or slowing down a cultivation process after a defined period of time

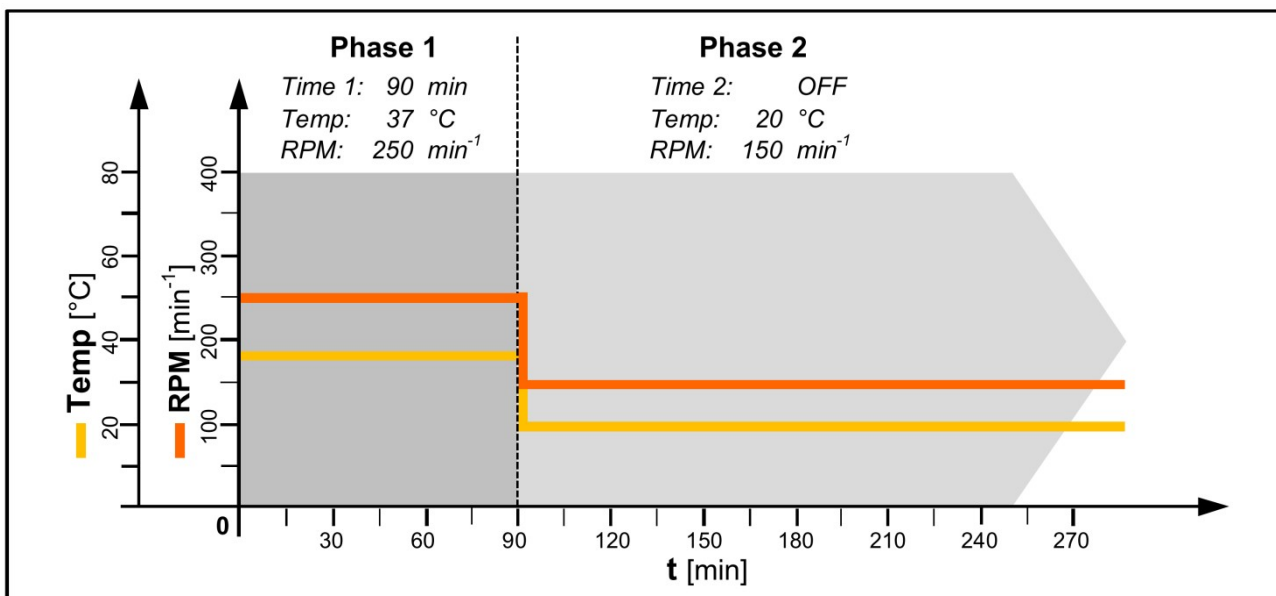

Cyclical Changing Between Phases 1 and 2

If the device is programmed this way, two different parameter settings will be repeated on an endless, precisely timed cycle. The two intervals (phase 1 and phase 2) alternate until the cultivation process is stopped manually by deactivating the parameters.

Example application:

- Simulation of day and night

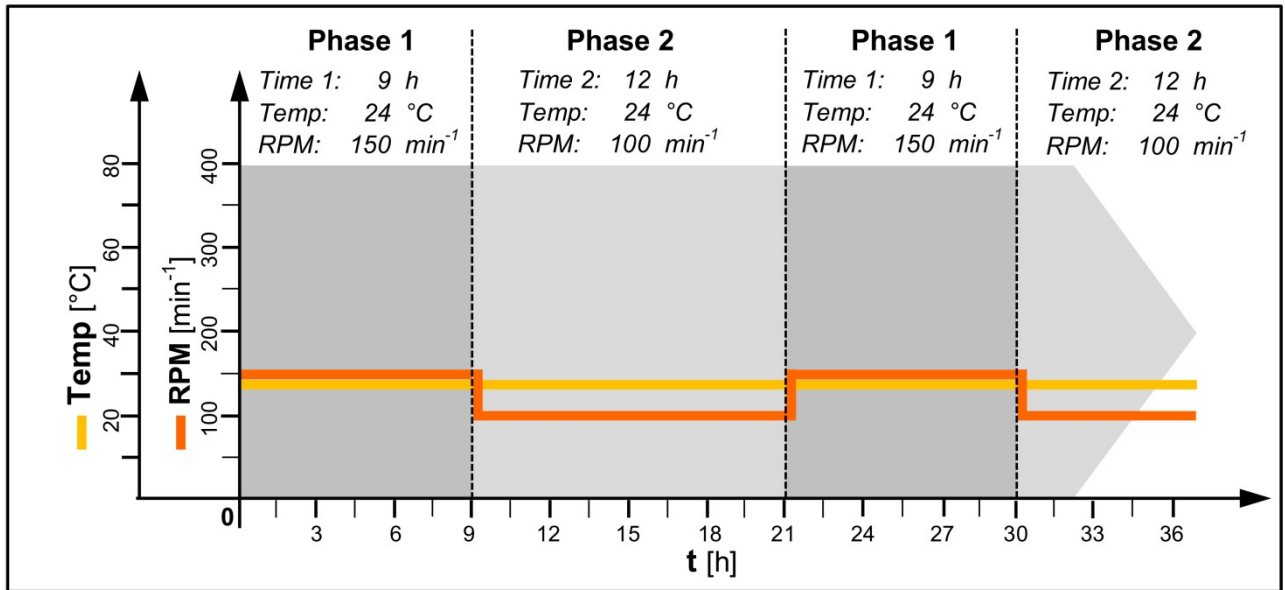

6.4.2 Programming Timer

Programming the timer for a cyclical change is a multi-step process:

- Set the setpoints (RPM and/or °C) for the first phase using the **F** button and activate the parameters.
- Set and activate the timer for the first phase using the **F** button.
- Set the setpoints (RPM and/or °C) for the second phase using the **FT** button and activate the parameters.
- Only for cyclical changes: Set and activate the timer for the second phase using the **FT** button.

Operation

Setting the Setpoints for Phase 1 (FT Button)

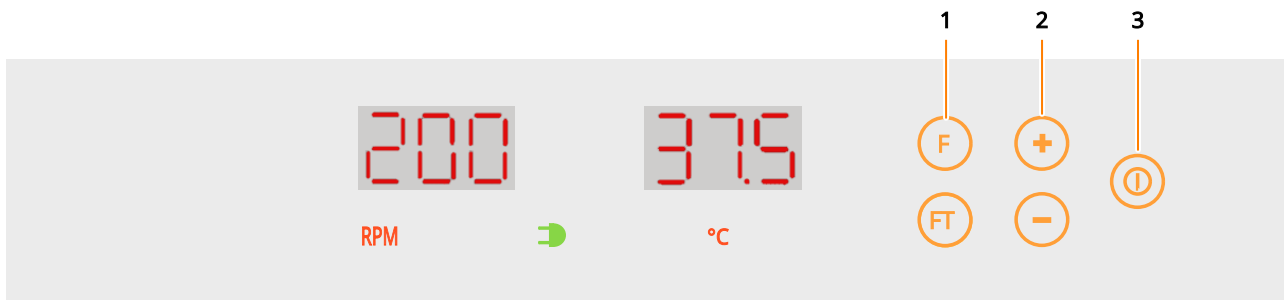

1. Press the **F** button (1) to select the parameter (RPM or °C) in question.
2. Press the **Plus** or **Minus** button (2) to set the setpoint you want to use for the selected parameter.
3. Press the **On/Off** button (3) to activate the parameter.
4. Repeat steps 1 – 3 as necessary for the other parameters.

Setting the Timer for Phase 1 (F Button)

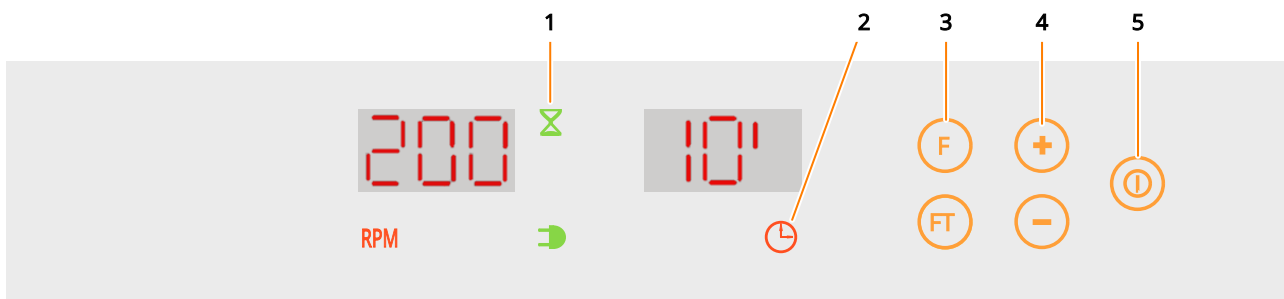

5. Press the **F** button (3) to select the timer function
 - The *Timer* parameter symbol (2) lights up.
6. Use the **Plus** or **Minus** button (4) to set the required duration.
7. Press the **On/Off** button (5) to activate the timer.
 - The *Timer active* function symbol (1) will flash.

Setting the Setpoints for Phase 2 (FT Button)

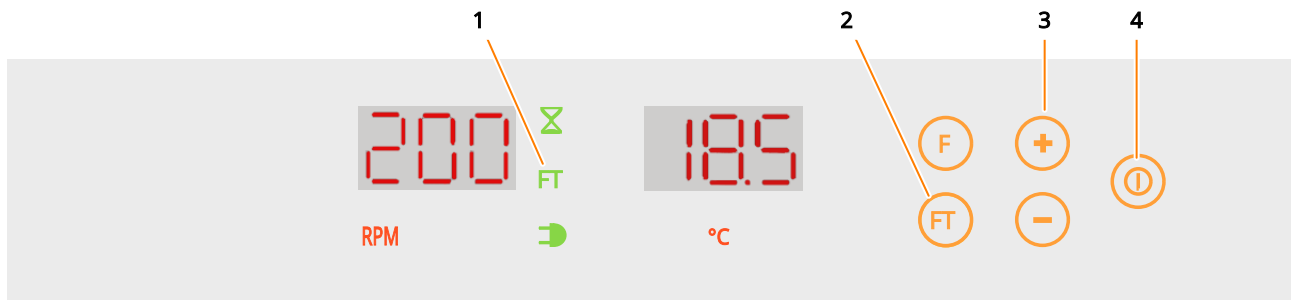

8. Press the **FT** button (2) to select the parameter (RPM or °C) in question.
 - ➔ The next phase (*FT*) function symbol (1) will light up.
9. Press the **Plus** or **Minus** button (3) to set the setpoint you want to use for the selected parameter.
10. Press the **On/Off** button (4) to activate the parameter.
11. Repeat steps 8 – 10 as necessary for the other parameters.

Only for Cyclical Changes: Setting the Timer for Phase 2 (FT Button)

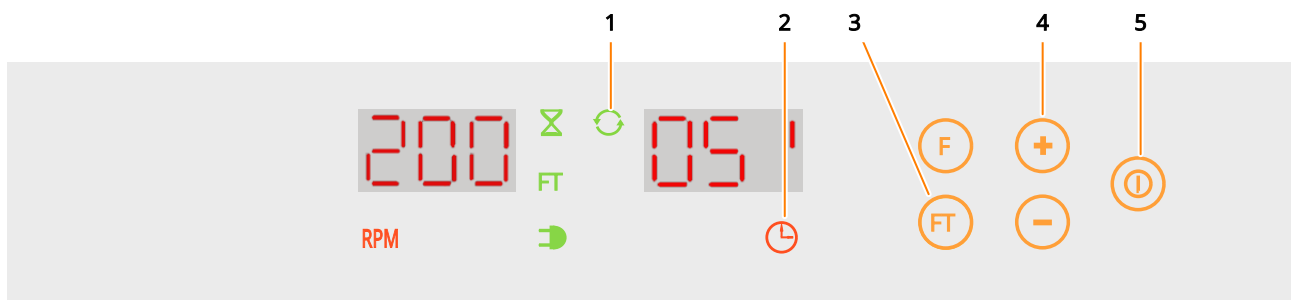

12. Press the **FT** button (3) to select the timer function
 - ➔ The *Timer* parameter symbol (2) lights up.
13. Use the **Plus** or **Minus** button (4) to set the required duration.
14. Press the **On/Off** button (5) to activate the timer.
 - ➔ The *cycle active* (1) function symbol will light up.

One-time Change

The device will run using the setpoints set for the first phase until the set time elapses. The *Timer active* function symbol will flash for the duration. At the end of the entered time, the setpoints for phase 2 are activated. The *Timer active* function symbol will go out. The setpoints remain active until they are changed manually.

Operation

Cyclic Change

The device will keep running and alternating between the setpoints for the first and second phases until it is switched off manually or the setpoints are modified. The *Timer active* and *Cycle active* function symbols will flash for the duration.



The timer function can be deactivated at any time by switching off the timer. The device will then continue running with the last active parameter settings.

6.4.3 Displaying the Remaining Time

To display the remaining time for the current phase, proceed as follows:

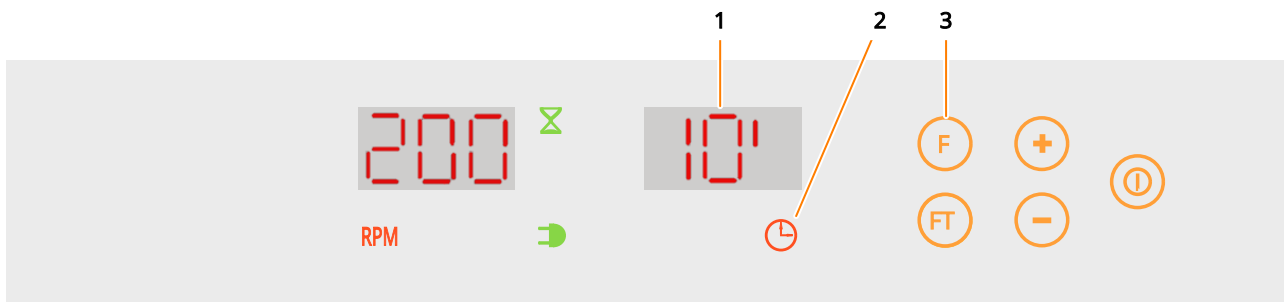

- ➔ Press the **F** button (3) to select the timer function
 - ➔ The *Timer* parameter symbol (2) lights up.
 - ➔ The remaining time of the timer will be displayed in the right view box (1).

6.4.4 Stopping the Timer

The timer function can be canceled at any time. To do so, proceed as follows:

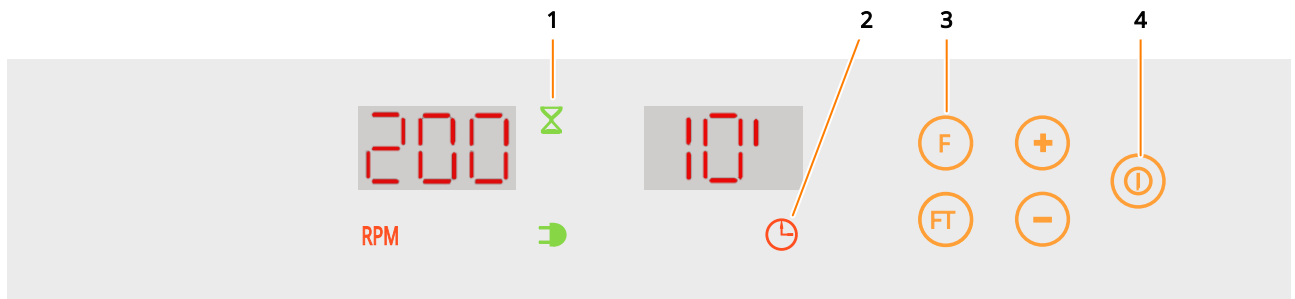

1. → Press the **F** button (3) to select the timer function
 - ➔ The *Timer* parameter symbol (2) lights up. The remaining time is displayed in the right view box.
2. → Press the **On/Off** button (4) to deactivate the timer.
 - ➔ The *Timer active* function symbol (1) goes out.
 - ➔ The device will now run with the set setpoints until it is switched off manually or the setpoints are modified.



If both timers are active, you only need to deactivate the first timer (**F** button); the second timer (**FT** button) is then deactivated automatically.

Operation

6.5 Using eve® to Operate the Device

Overview



For detailed information on how to use eve® to operate the device, please read the document device-tation supplied with eve®.

The device comes with the option of being operated from an external computer via the Ethernet interface. To externally control the device, you need the eve® bioprocess platform software. The Ethernet interface can be used to send or receive data. For example, setpoints can be sent to the device or parameters can be activated or deactivated. In addition, the actual values of the parameters and the values measured on the sensors can be transferred to eve® and thus logged.



To use the Ethernet interface of the device with other tools, a special communication protocol is required. For more information, contact INFORS HT.

Keep in Mind

The following points must be observed if you want to use eve® to control the device:

- The parameters cannot be activated/deactivated manually eve®. If a permissible setpoint is sent to the device, the parameter is activated automatically. A parameter can be deactivated by sending the setpoint 0 to the device.
- If the device is connected to eve®, all setpoints set in eve® are applied automatically. Any setpoints manually set on the device are overwritten. If a parameter is deactivated on the device, this remains deactivated, even if eve® sends a setpoint.

Displays on the Device

If the device is controlled using eve®, this is displayed on the device as follows:

- While the device is being registered in eve®, the working light of the device flashes. This is used, in particular, to identify the unit when devices are stacked.
- If setpoints are written to the device, the function symbol *EXTERN* (2) flashes.

EX

Display IP Address of the Device

The IP address of the device can be displayed. To do so, proceed as follows:

1. ➤ Press and hold the **FT** button for at least five seconds.
 - ➔ The function symbol for *external (EX)* lights up.
 - ➔ The individual number blocks of the IP address are displayed in succession. The left view box shows which of the four blocks of the IP address it is. The right view box shows the numbers.
2. ➤ To close the IP address view, press the **FT** button again.

Example: IP address 192.168.0.19

Left view box	Right view box
iP4	19
iP3	0
iP2	168
iP1	192

6.6 Using the Operating Time Counter

The operating time counter indicates how long a device component has been in operation. The left-view box displays the hours in thousands; the right view box displays hours from 0 to 999.

To activate the operating hours display, proceed as follows:

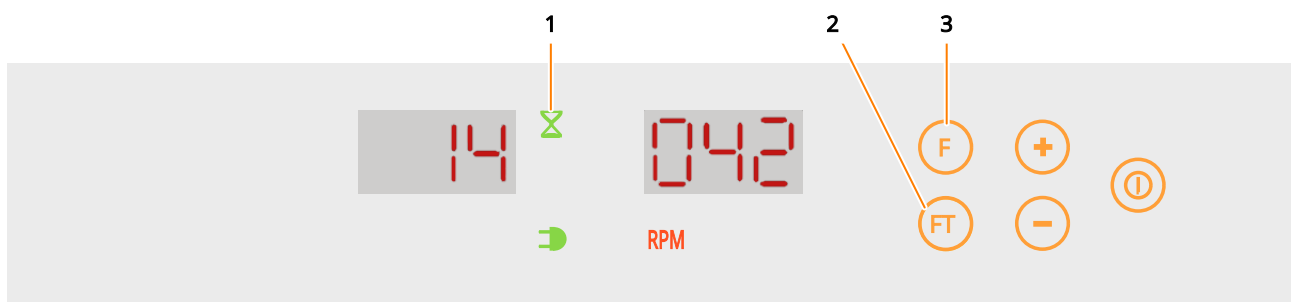

Operation



→ Press and hold the **F**- and **FT**-buttons (3 and 2) at the same time.

➔ The *Timer active* function symbol (1) lights up.



➔ The operating hours for the individual components are displayed one after the other:

- Operating hours – power supply on
- Operating hours – motor controller

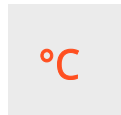

- Operating hours – temperature control

Example above: Operating hours for motor controller = 14042 hours

6.7 Switching off the Device

! NOTICE

Parameters that have not been deactivated before the device is switched off are automatically activated when the device is switched on again. This can damage the device and the cultivation vessels.

- Deactivate all active parameters before switching off the device.
- Do not leave any objects in the incubation chamber when the device is switched off.

! NOTICE

Switching the device on and off frequently places strain on the electronic components. As such, only switch off the device prior to longer breaks in use (> 1 day). When interrupting operation for short periods of time, simply deactivate the parameters.



The parameter setpoints are stored for approx. one month.

To switch off the device, proceed as follows:

1. ➤ Deactivate all active parameters.
2. ➤ Press the power switch on the top right of the casing.
3. ➤ If the device is not going to be used for an extended period of time, unplug the power plug.

6.8 Behavior in Case of a Power Interruption

If the power supply to the device is interrupted during a running cultivation process (e.g. by flicking the power switch or in case of a power failure), all parameters and timer setpoints as well as the residual time of the last active timer phase are stored.

If the power supply is restored, the device automatically restarts with the last stored setpoints. If a timer was active prior to the interruption to power supply, the device restarts with the residual time of the last active phase and the setpoints stored for this phase.

The alarm message *P. out* appears in the view boxes as a warning. The alarm message can be confirmed by pressing any button; and then disappears.

Rectifying Faults

7 Rectifying Faults

7.1 Safety Notes



WARNING

Improper rectification of faults may lead to dangerous situations.

- To prevent life-threatening electric shocks, always switch off the device and disconnect it from the power supply before carrying out any work to find the cause of the fault or to rectify the fault.
- Never remove the covers of the device.
- Damaged parts may only be replaced by an INFORS HT service technician, a licensed dealer or authorised expert personnel.
- Contact the manufacturer in case of faults that cannot be resolved by following the notices below. For service contact details, see page 2.

7.2 Messages in the View Boxes

Faults in the device are divided into two categories:

- **Alarms** refer to errors in the process, for example, when the actual parameter values deviate from the setpoints. Alarms do not directly affect the process; the device can continue running without any restrictions.
- **Error messages** relate to technical faults in the device. Depending on the type of the error in question, either the device or individual components is brought to an immediate stop. In such cases, it is not possible to put the device back into operation until the error has been resolved.

7.2.1 Alarm Messages

Parameter Alarms

A parameter alarm is triggered if the actual value of a parameter deviates too much from the setpoint after a certain waiting time. The maximum permissible deviation from the setpoint and the waiting time are set in the factory and cannot be changed.



An alarm is only triggered if the value of the parameter does not change for a certain period of time. If there is a fluctuation, the counter for triggering the alarm is reset. Switching the device off/on, opening/closing the door or changing the setpoint will also reset the counter.

A parameter alarm is displayed as follows:

- Acoustic signal
- Display shows the message *Hi* or *Lo*

Alarms are reset automatically as soon as the actual value moves back into the target range.

The following parameter alarms are possible:

Alarm	Meaning	Deviation from setpoint	Waiting time
<i>°C Hi/Lo</i>	Temperature too high/low	$> \pm 1\text{ °C}$	20 min (18 °C to 40 °C)
			50 min (< 18 °C / > 40 °C)
<i>RPM Hi/Lo</i>	Rotation speed too high/low	$> \pm 10\text{ min}^{-1}$	2 min

Other Alarm Messages

Alarm/message	Meaning
<i>P. out</i>	<p>The alarm message <i>P. out</i> appears if the device was switched on again manually or automatically after a power interruption and at least one parameter was switched on before the power interruption. The message can be confirmed by pressing any button.</p> <p>For details, see ➔ Chapter 6.8 'Behavior in Case of a Power Interruption' on page 71.</p>
<i>door</i>	The device door is open.

Rectifying Faults

7.2.2 Error Messages

Error messages are generated when the device develops a fault, e.g. if a component is defective or the table is jammed.

An error message is displayed as follows:

- Acoustic signal
- The display shows the message *Err* and the corresponding error code.

Error messages can be confirmed by pressing the **F** button. The acoustic signal stops, but the error message is still displayed in the view box of the affected parameter. To put the device or the affected parameter back into operation after the fault has been rectified, the device must be switched off and on again once.



The faults listed here can generally not be resolved by the operators. If an error message is displayed, one of the manufacturer's service technicians needs to be consulted.

Error message	Description	Solution
<i>Err Thi</i>	The measured temperature falls outside the permissible range (> 75 °C).	Contact your local INFORS HT representative.
<i>Err Tlo</i>	The measured temperature falls outside the permissible range (< 2 °C).	Contact your local INFORS HT representative.
<i>Err Sen</i>	The Pt100 sensor is not returning any readings. The Pt100 sensor is not connected correctly or is defective.	Contact your local INFORS HT representative.
<i>Err bLc</i>	The drive or the shaking table is blocked.	<ol style="list-style-type: none"> 1. → Remove foreign objects from the incubation chamber, if necessary, dismount the shaking table to do so (→ Chapter 8.2.3, page 81). 2. → If this does not help, contact your local INFORS HT representative.
<i>Err bLt</i>	The drive belt is torn.	Contact your local INFORS HT representative.
<i>Err ctL</i>	The motor or the controller of the motor is defective.	Contact your local INFORS HT representative.

7.3 Fault Tables

The tables below describe potential faults that do not usually trigger an error message on the display or – with a few exceptions – an alarm signal.

General Faults

Fault description	Cause	Remedy	Personnel
After activating the power switch, the display does not light up.	Power supply of the device interrupted.	<ul style="list-style-type: none"> ■ Check if the plugs are plugged in correctly. ■ Check the mains connection. 	Operator
	The device fuse has triggered.	Change the fuse (→ chapter 7.4, page 78). If the fuses trigger several times, contact your local INFORS HT representative.	Operator
Door does not open fully.	The device is switched off.	Switch on the device.	Operator
	The door is under pressure.	Close the door completely and then open it again.	Operator
	Door mechanism defective.	Contact your local INFORS HT representative.	INFORS HT service technician or licensed dealer
The tray is not released when the door is opened.	The door is not fully open.	Push the door down to its bottom position.	Operator
The tray cannot be locked.	There is a foreign object jamming the locking mechanism.	Remove the foreign object.	Operator
	The tray is jammed due to foreign objects under the table.	Detach the table from its axis, tip it up and remove the foreign objects (→ chapter 8.2.3, page 81).	Operator
	The tray is bent.	Replace the tray.	Operator
The working light does not work.	The working light is deactivated in the service mode.	Have the working light activated. Therefore contact your local INFORS HT representative.	INFORS HT service technician or licensed dealer
	The lighting element is defective.	Contact your local INFORS HT representative.	INFORS HT service technician or licensed dealer

Rectifying Faults

Faults in Conjunction with the "Rotation speed" Parameter

Fault description	Cause	Remedy	Personnel
Strong vibrations occur.	The load is too heavy or too light.	Reduce/increase the load to the prescribed value.	Operator
	The load is distributed unevenly.	Load the tray in the centre. If possible, do not place any heavy weights in the corners of the tray.	Operator
	The rotation speed is too high.	Reduce the rotation speed.	Operator
	The device is not standing straight.	Level the bench or the device (adjustable foot on the base).	INFORS HT service technician or licensed dealer
	The substrate is too weak.	Place the device on a stable substrate.	INFORS HT service technician or licensed dealer

Faults in Conjunction with the "Temperature" Parameter

Fault description	Cause	Remedy	Personnel
The temperature fails to reach the desired set-point.	The door is not closed completely.	Close door completely.	Operator
	The internal cooling unit is not switched on.	Switch on cooling.	Operator
	No cooling is available and the difference to the ambient temperature is too small.	Increase the setpoint or equip the device with cooling.	Operator
	Error during temperature measurement.	Check whether the Pt100 sensor is working properly. In case of a defect, contact your local INFORS HT representative.	Operator
	Fans are defective, air circulation in the incubation chamber is therefore insufficient.	Contact your local INFORS HT representative.	INFORS HT service technician or licensed dealer
Poor cooling performance. The desired set-point cannot be reached even though the cooling unit is in operation.	The door is not closed completely.	Close door completely.	Operator

Rectifying Faults

Fault description	Cause	Remedy	Personnel
Poor cooling performance. The desired set-point cannot be reached even though the cooling unit is in operation.	The room temperature is too high. IMPORTANT: The room temperature refers to the temperature directly on the device. This can be significantly higher than the temperature in other parts of the room.	<ol style="list-style-type: none"> 1. → Reduce the room temperature. 2. → Use a fan to improve air circulation. 3. → Move the device. 	Operator INFORS HT service technician or licensed dealer
	Other devices with strong heat radiation are located in the immediate vicinity of the device (e.g. ultra-low freezers or refrigerated centrifuges).	<ol style="list-style-type: none"> 1. → Use a fan to improve air circulation. 2. → Place a barrier between the devices. 3. → Move the device. 	Operator INFORS HT service technician or licensed dealer
	A barrier in the room prevents circulation of cold air.	<ol style="list-style-type: none"> 1. → Remove the barrier. 2. → Move the device. 	Operator INFORS HT service technician or licensed dealer
	The room temperature is not constant (e.g. because the air conditioning is turned down on the weekend).	Ensure that the room temperature is constant.	Operator
	Required minimum distances for air circulation are not observed. The device has been pushed back against the wall.	Move the device to ensure that heat can escape and heat does not accumulate.	INFORS HT service technician or licensed dealer
	The device was positioned under a table without air vent.	Move the device.	INFORS HT service technician or licensed dealer
	The air vents are covered.	Remove all objects that cover air vents.	Operator



Re-measuring the temperature only provides reliable information when using calibrated measuring tools, and only if they are used at points specified by INFORS HT. Measurements taken at undefined points in the casing will not produce any usable data.

For information about temperature measuring, contact your local INFORS HT office or request a quote for calibrating the parameters.

Rectifying Faults

7.4 Replacing Device Fuses



The device fuses may only be replaced by fuses of the same rating. For information on the requirements regarding fuses, see → Chapter 11.2.3 'Electrical Connection and Power Values' on page 88.

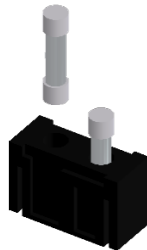
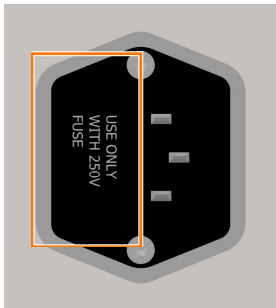

To replace a defective device fuse, proceed as follows:

1. → Turn off the device and pull out the power plug.
2. → Release the slot for the device fuses next to the mains connection by pressing together the two flaps and pulling out at the same time.
3. → Remove the defective device fuse.
4. → Insert a new device fuse with the correct number of Amperes.
5. → Push the plug as far back in the opening as possible until it snaps in.
6. → Restore the power supply to the device.

7.5 Returning for Repair

The provider must return the device or the faulty component part(s) to the manufacturer if, after consulting the service department of the local dealer or the manufacturer, on-site diagnosis and/or repair is not possible.



If the device, component or accessory has to be returned to the manufacturer for repair, a legally compliant declaration of decontamination is required for the safety of all parties involved and to comply with legal requirements (→ Chapter 2.10 'Declaration of Decontamination' on page 22).

8 Cleaning and Maintenance

WARNING

Improper cleaning and maintenance of the device may lead to dangerous situations.

- To prevent life-threatening electric shocks, always switch off the device and disconnect it from the power supply before carrying out any maintenance or cleaning.
- Never remove the covers of the device.
- Damaged parts may only be replaced by an INFORS HT service technician, a licensed dealer or authorised expert personnel.

8.1 Maintenance

The device requires hardly any maintenance. This reduces the running costs to certain regular checks and cleaning. The following table describes the maintenance work that is required to ensure optimum, fault-free operation.

If increased wear is detected during regular checks, the required maintenance intervals must be shorted in accordance with the actual signs of wear. Keep in mind that various media or gases have more or less corrosive effects on the metal parts. When using particularly aggressive substances, more frequent checks are required to maintain smooth device operation.

Contact the manufacturer if you have questions about maintenance work and intervals.

Interval	Maintenance work	Personnel
Prior to each use	Dichtungen am Gerät, vor allem an der Tür, prüfen und gegebenenfalls ersetzen lassen.	Operator
	Innenraumbeleuchtung auf Funktion überprüfen, bei Bedarf Leuchtmittel ersetzen lassen.	Operator
After each use	Gerät reinigen, gegebenenfalls sorgfältig desinfizieren.	Operator
Annually	Verwendete Sensoren mindestens einmal im Jahr kalibrieren lassen, um die Genauigkeit der Messresultate aufrechtzuerhalten.	Technician
Every 3 years	Bei Verwendung der Option "Kühlung" das Kühlmittel ersetzen lassen. Dazu INFORS HT kontaktieren.	INFORS HT service technician or licensed dealer

Cleaning and Maintenance

8.2 Cleaning and Disinfection

If substances, especially substances hazardous to health, have been spilled on or in the device, the device must be thoroughly cleaned and disinfected. The device should also be routinely cleaned and disinfected at regular intervals to ensure trouble-free operation.

If you are not sure about the compatibility of cleaning agents and disinfectants, contact INFORS HT.

! NOTICE

Insufficient cleaning and disinfection can lead to damage to cultures due to contamination.

8.2.1 Cleaning the Device

Detergent

Mild detergents, e.g. dishwashing liquid or neutral cleaning agents, are suitable for all surfaces:

- Exterior surfaces of the casing
- Front window
- Interior surfaces of the casing
- Steel plate covers
- Table
- Trays (incl. clamps and other holders)

! NOTICE

Aggressive detergents, solvents and abrasive cleaning utensils (hard sponges, brushes) can scratch surfaces, damage the device and impair its function.

Notices on Cleaning

To clean the surfaces, use a soft cloth, ideally lint-free. This applies in particular to the front window.

Spray

When cleaning the base tray, only use a wet cloth, never pour water into the tray. Make sure that no water splashes into the bearings. After cleaning the device, especially the interior and the base tray, dry it with a cloth.

Air Vents and Fan

Over time, dust and other contaminants can accumulate on the vents and fans and other exposed areas. This may affect the operation of the device, for example, if the air circulation for cooling the electronic components is restricted. Dust and other impurities can be carefully removed with a damp cloth or with a vacuum cleaner.

8.2.2 Disinfecting the Device

Only use quaternary ammonium compounds for wipe-down disinfection. Approved and recommended disinfectants: Fermacidal D2 and Biocidal ZF.

NOTICE

Heat (temperatures above 80 °C), aggressive disinfectants such as chlorine bleach and UVC radiation can damage the device and significantly limit the function and service life of the device.

We recommend against using UV lamps for disinfection of the device because the UV rays can massively damage the housing in case of multiple applications.

8.2.3 Cleaning and Disinfecting the Base Tray

If glass is broken or large amounts of liquid are spilled, liquid may accumulate underneath the shaking table. To drain leaked liquids, the device has a discharge outlet on the left side. In order to be able to clean the base tray in case of glass breakage or other contamination by culture liquids, the table can also be detached from the counterweight and folded upwards.



CAUTION

After being folded up, the table must be held in position by hand. If the table is not secured properly, there is a risk of it folding back down again. This can cause injuries.

- If possible, have a second person hold the table in place once it has been folded up. Alternatively, you can place an object under the table to stop it from folding back down.
- Proceed with caution when folding the table back down.

To dismantle the shaking table and the base tray, proceed as follows:

Folding up the Table

1.  Open the device door all the way.
2.  Remove the tray (→ Chapter 6.2.2 'Inserting and Removing the Tray' on page 55).
3.  Switch off the power switch and pull out the power plug.

Cleaning and Maintenance

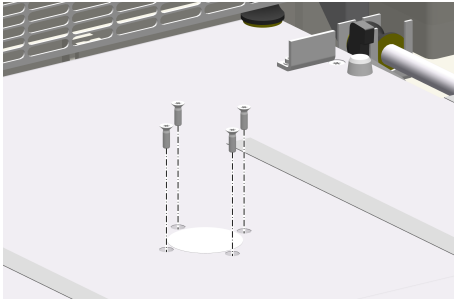

4. Undo the hexalobular socket screws (4 M5x16) on the table's drive hub using the screwdriver provided and remove them.

! NOTICE

No screws must be removed other than the four fastening screws on the drive hub.

5. Tilt the table upwards by no more than 30°.
6. Hold the table in its tilted up position (or, ideally, get a second person to do so), or use a suitable object to hold it there.
7. Clean the base tray with a mild detergent. Larger quantities of liquid can be drained off via the discharge outlet on the left side.
8. Thoroughly dry the base tray using paper towels.
9. Carefully apply disinfectant to the affected areas of the base tray and let it take effect.

! NOTICE

Disinfectant may only be placed in the base tray. It must not come into contact with the metal parts of the shaking mechanism or the components of the upper part of the device.

In particular, all ball bearings of the shaker drive must not come into contact with disinfectants!

10. After the exposure time (see manufacturer's instructions), remove the disinfectant (wipe up).
11. Wipe or rinse with (sterile) water to remove all residues.
12. Carefully place the table on its rotary axis. When doing so, align the rotary axis so that the threaded holes on the table are positioned directly over the holes on the rotary axis.
13. Insert the hexalobular socket screws and tighten them cross-wise.



If any of the hexalobular socket screws are lost or damaged, make sure that they are always replaced using original screws (M5x16).

Cleaning the Base Tray

Disinfecting the Base Tray

Folding down the Table

9 Transport and Storage

Inbound delivery and transport to the assembly location are performed only by INFORS HT employees or by persons authorized by INFORS HT. Nonetheless it is possible that the provider's personnel is entrusted with transport tasks in the context of on-site transport. In this case, observe the following notes.

9.1 Transport



WARNING

Improper transport, use of incorrect auxiliary tools and careless handling of the device may lead to injuries and significant damage to property.

When transporting the device, observe the following:

- Prior to moving the device, transport fasteners (rubber wedges) must be inserted to prevent uncontrolled movements of the table.
- Always work in pairs and use suitable auxiliary equipment when transporting the device.
- Especially when using auxiliary tools, it is important to keep in mind that the device's centre of gravity is not in the middle.

9.2 Storage

- Decontaminate, thoroughly clean and dry the device every time before placing it in storage.
- Store the device and its components clean, dry and protected against dust, dirt and liquids.
- Store the device and its components in a cool place with low humidity but protected against frost.
 - Storage temperature: 10 °C to 35 °C
 - Relative humidity, non-condensing: 10 % to 85 %
- Protect the device from aggressive media, direct sunlight and vibrations.

Disposal

10 Disposal

General Information

Once the end of use has been reached, the device must be dismantled and disposed of in an environmentally friendly manner. The materials must be disposed of in accordance with national and local legislation. The local municipal authority or specialist waste disposal companies can provide information on environmentally friendly disposal.

If no special return arrangements have been agreed, INFORS HT devices can be returned to the manufacturer or licensed dealer for disposal with the required declaration of decontamination (→ Chapter 2.10 'Declaration of Decontamination' on page 22).

WARNING

- Electronic waste, electronic components, lubricants or other auxiliary materials/supplies are subject to hazardous waste regulations and may only be disposed of by registered specialist disposal firms.
- Before disposal, ensure that the device is free of toxic or infectious substances.

Disposal Information in accordance with the WEEE Directive (2012/19/EU)



The device is marked with the symbol of a crossed-out wheeled bin in accordance with Directive 2012/19/EU on waste electrical and electronic equipment (WEEE). This symbol indicates that the device must not be disposed of with household waste. To prevent environmental damage and health risks caused by improper disposal, the device must be taken to a separate collection point for electrical and electronic equipment at the end of its service life.

Disposal Information Hazardous Substances

Hazardous substance	Use	Disposal instructions
R134a	Devices with cooling, primary cooling circuit	The refrigerant R134a is a fluorinated greenhouse gas with high global warming potential. To avoid environmental damage and health risks, it must not be allowed to enter the sewage system, the ground, or waterways. Disposal may only be carried out by authorized specialist companies that are licensed to handle and take back fluorinated greenhouse gases.
Antifrogen L	Devices with cooling, secondary cooling circuit	Antifrogen L is hazardous to water and must therefore not be released into the environment. Residues and contaminated materials must be disposed of as hazardous waste in accordance with local regulations. Disposal may only be carried out by authorized specialist companies.

11 Technical Data

11.1 Dimension Drawings

Single Unit

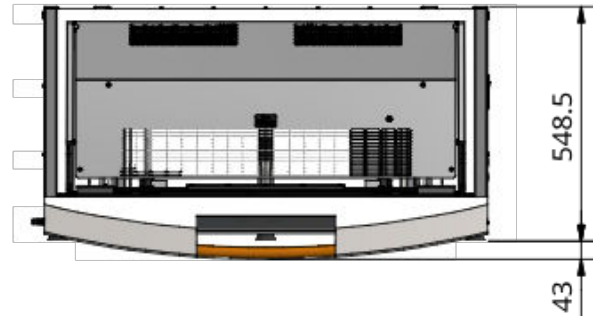
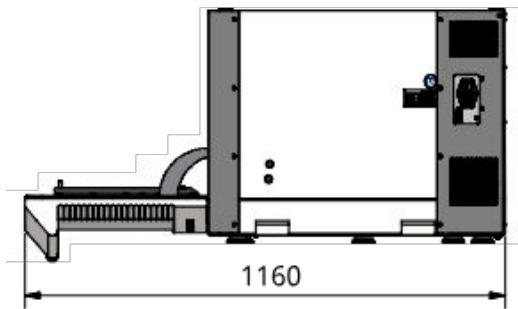

Two Units Stacked with High Base

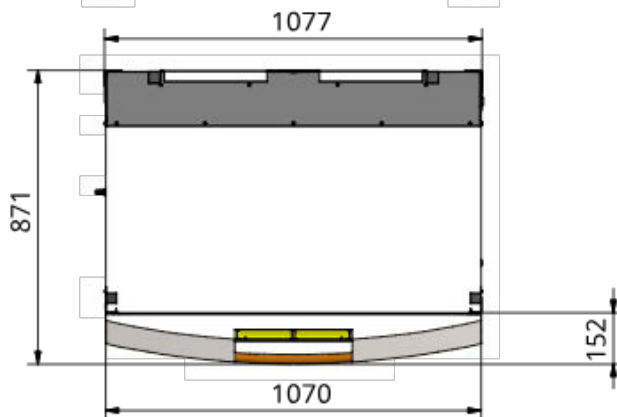
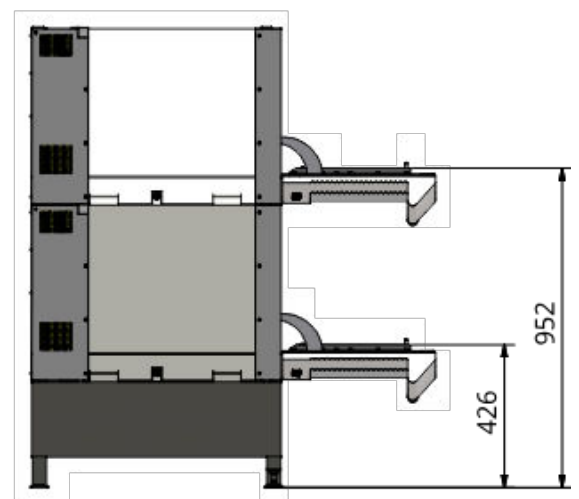
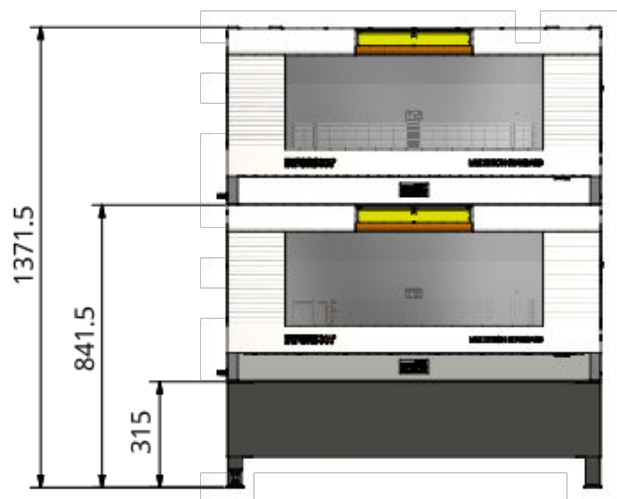

Technical Data

Three Units Stacked with Low Base and Cooling

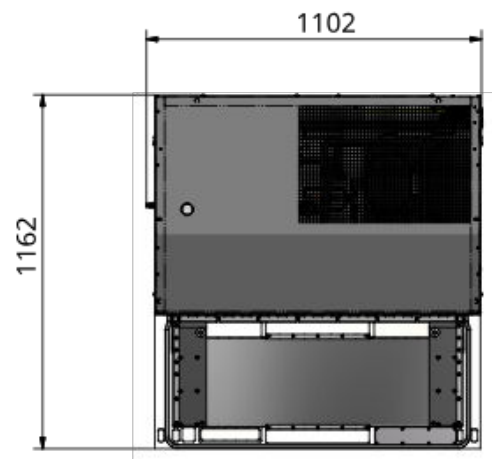
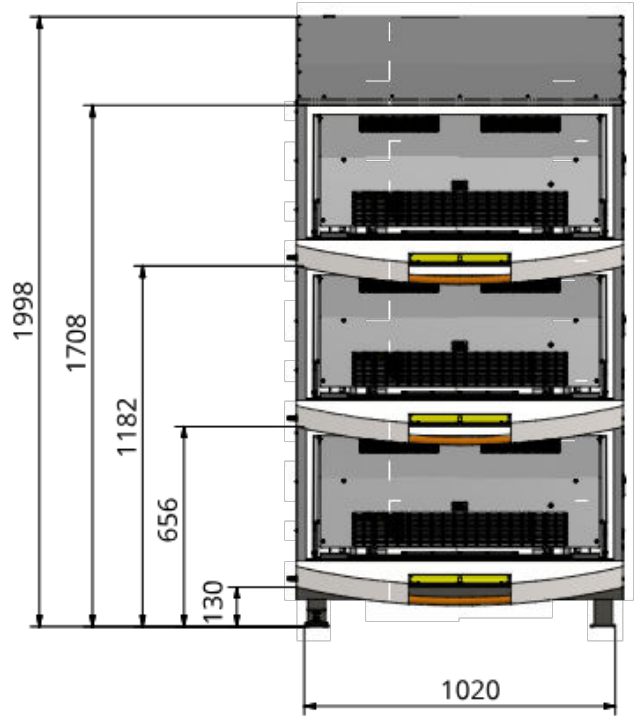
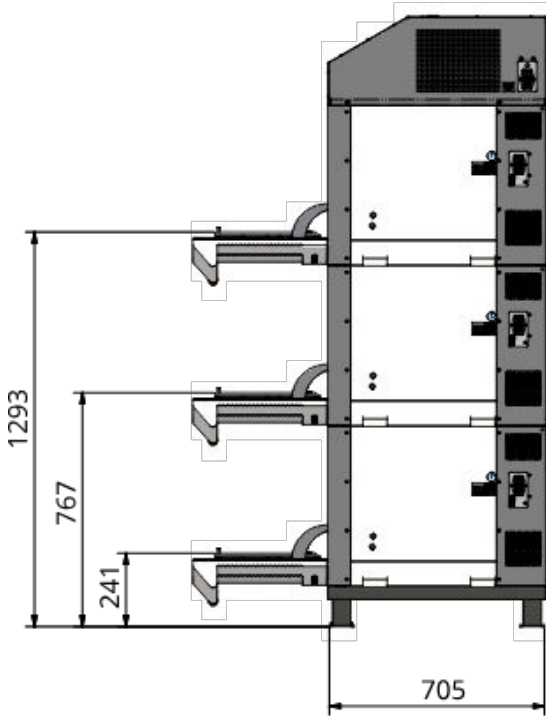

11.2 Specifications of the Basic Unit

11.2.1 Weight

Weight of the Basic Unit (without Base and Cooling)

Data	Value	Unit
Single unit (25 mm throw)	94	kg
Single unit (50 mm throw)	96	kg

Weight Substructure

Data	Value	Unit
Rubber feet	6	kg
Low base	25	kg
High base	23	kg

Stacked Devices (50 mm Throw)

Data	Value	Unit
Two units stacked with low base	239	kg
Three units stacked with low base	339	kg

Additional Weight with Cooling

Data	Value	Unit
Cooling unit	approx. 65	kg

Technical Data

11.2.2 Dimensions

Dimensions of Single Unit (without Base)

Data	Value	Unit
Width	1070	mm
Depth (door closed)	871	mm
Depth (door open)	1162	mm
Height	530	mm



For detailed information regarding the dimensions, refer to the dimension drawings (→ Chapter 11.1 'Dimension Drawings' on page 85).

Interior Dimensions (Incubation Chamber)

Data	Value	Unit
Width	925	mm
Depth	550	mm
Height	390	mm

11.2.3 Electrical Connection and Power Values

Base Unit

Data	Value	Unit
Voltage	230	VAC
Frequency	50/60	Hz
Max. power consumption	880	W
Max. current consumption	3.8	A
Consumption in stand-by	6	W
Device fuses (two 5 x 20 mm fuses, time lag)	10	A

Cooling

Data	900 W (version 230V/50Hz)	900 W (version 230V/60Hz)
Max. power consumption	540 W	690 W
Max. current consumption	4.2 A	4.6 A
Device fuses (two 5 x 20 mm fuses, time lag)	10 A	10 A

11.2.4 Working Light

Data	Value	Unit
Power consumption	350	mA
Power	1	W

11.2.5 Materials

Data	Value
Casing	Polyurethane
Interior panels	Stainless steel (AISI 304)
Table	Aluminium, anodized

11.2.6 Emissions

Data	Value	Unit
Sound pressure	< 70	dB(C)

Technical Data

11.2.7 Operating Conditions

Data	Value	Unit
Temperature range	10 to 30	°C
Relative humidity, non-condensing	10 to 85	%
Altitude operating location	max. 2000	M above sea level
Pollution degree as per EN 61010-1	2	
Maximum load	19	kg
Min. distance from walls, ceilings and other devices	100	mm



The specified temperature range refers to the temperature directly on the device. In case of heat build-up due to insufficient ventilation, the temperatures on the device can be significantly higher than the room temperature.

11.2.8 Protection Type

Data	Value
Protection class as per DIN EN 60529	IP20

11.2.9 Operating and Auxiliary Materials

! NOTICE

Using the wrong auxiliary materials can result in significant damage to property.

Only use the auxiliary materials prescribed by the manufacturer in accordance with the table below.

Description	Approved/applied products
Refrigerant (primary cooling cycle, cooling compressor)	R134a
Cooling liquid (secondary cooling cycle)	<ul style="list-style-type: none"> ■ Based on 1,2-propandiol with inhibitor (must be suitable for copper) ■ Approved for the food and pharmaceutical sectors <p>Ex factory: 30 % Antifrogen L, 70 % water</p>
Detergent	<ul style="list-style-type: none"> ■ Mild neutral cleaning agent ■ Dishwashing detergent
Disinfectants	Quaternary ammonium compounds

11.3 Specifications of Parameters

11.3.1 Shaker Drive

Data	Value	Unit
Drive	External rotor motor	
Direction of rotation	Clockwise	
Throw	25 or 50	mm
Increment	1	min ⁻¹
Accuracy control (at maximum rotation speed, full scale)	± 1	%

Technical Data

Maximum Permissible Setpoints for the Rotation Speed



The following information is based on an ideal tray load of 14 kg made up of standard Erlenmeyer flasks with no baffles and a fill level of 30%. For information on the optimum load weight depending on the rotation speed, see ➔ Chapter 11.3.3 'Ideal Loading Weights' on page 999.

The following guidelines for maximum rotation speeds are specified to prevent damage. Hence, they must be observed though further restrictions (e.g. tray with Sticky Stuff adhesive matting) must be taken into account.

The minimum rotation speed for all unit variants is 20 min⁻¹. The maximum rotation speed of a device unit depends on the throw and the position of the unit in the stack:

Single unit	25 mm throw	50 mm throw
	400 min ⁻¹	350 min ⁻¹

Two units stacked (low base)	25 mm throw	50 mm throw
Top unit	400 min ⁻¹	300 min ⁻¹
Bottom unit	400 min ⁻¹	350 min ⁻¹

Two units stacked (high base)	25 mm throw	50 mm throw
Top unit	250 min ⁻¹	250 min ⁻¹
Bottom unit	400 min ⁻¹	350 min ⁻¹

Three units stacked	25 mm throw	50 mm throw
Top unit	350 min ⁻¹	250 min ⁻¹
Middle unit	400 min ⁻¹	300 min ⁻¹
Bottom unit	400 min ⁻¹	350 min ⁻¹

All these values are intended solely as guidelines (not guaranteed). Depending on the load, higher rotation speeds are possible; in this case, the rotation speed should be increased slowly. In such cases, the user is responsible for determining the maximum possible rotation speed based on the vibrations and the vessel holders (the clamps may need to be secured) and communicating them. If vibrations occur, reduce the shaking speed until the device runs smoothly. Alternatively, increase or decrease the load until the device runs smoothly.

Technical Data

Maximum shaking speeds with Sticky Stuff

For a detailed description of the maximum permissible rotation speeds when using the Sticky Stuff adhesive matting, see → Chapter 4.1.6 'Tray with Sticky Stuff' on page 40.

11.3.2 Temperature Control

Cross-flow Fan

Data	Value	Unit
Power	750	W
Air circulation	360	m ³ /h

Measurement/Control

Data	Value	Unit
Control	PID controller	
Sensor type	PT100 class 1/3 DIN B	
Setting range	4.0 to 65.0	°C
Increment	0.1	
Accuracy control 4 °C to 50 °C	± 0.3	°C
Accuracy control > 50 °C	± 0.5	°C

Technical Data

Information on Temperatures that can actually be Reached

The temperature range limited by the measuring and control unit ranges from 4 °C to 65 °C. The temperatures that can actually be reached depend on a variety of factors, such as the ambient temperature, the ventilation in the stack and the temperature of the other devices in the stack. As such, the following guideline values (no guarantees) only apply under optimal conditions. In order to reach these guideline values, the device must be free-standing and the heat it generates must be able to dissipate unobstructed.



The specified ambient temperature refers to the temperature directly at the device. In case of heat build-up due to insufficient ventilation, the temperatures on the device can be significantly higher than the room temperature.

Configuration	Without cooling	With cooling
Single unit	6 °C above ambient temperature	12 °C below ambient temperature
Two units stacked	6 °C above ambient temperature	10 °C below ambient temperature
Three units stacked	6 °C above ambient temperature	10 °C below ambient temperature

11.3.3 Ideal Loading Weights

The ideal load for a tray falls into the following ranges (mass incl. tray, clamps, flasks and filling):

Throw	Rotation speed [min ⁻¹]			
	Up to 250	250 or higher	Up to 350	350 or higher
25 mm	–	–	9 – 19 kg	12 – 16 kg
50 mm	9 – 19 kg	12 – 16 kg	–	–

With the above-mentioned load, the device is ideally balanced. Both higher and lower loads can cause an imbalance, which can result in vibrations at higher rotation speeds. If vibrations occur, the tray can be weighted down with additional flasks filled with water until the optimum mass is reached.

12 EU Declaration of Conformity

EU-Konformitätserklärung

EU-Declaration of conformity

Déclaration UE de conformité

INFORS HT

Infors AG, Headoffice, Switzerland
Rittergasse 27, CH-4103 Bottmingen
T +41 (0)61 425 77 00
info@infors-ht.com, www.infors-ht.com

Hersteller
Manufacturer
Fabricant

Infors AG
Rittergasse 27
CH-4103 Bottmingen

Bezeichnung
Designation
Désignation

Inkubationsschüttler
Incubation shaker
Incubateur agité

Typ
Type
Type

Multitron Standard

Ab Release
From release
A partir du version

2.0.0

Ab Seriennummer
From serial number
A partir du numéro de série

S-000137279

Dieses Gerät entspricht den grundlegenden Anforderungen der Richtlinien

This device is in compliance with the essential requirements of directives

Cet appareil est conforme aux exigences essentielles des directives

Maschinenrichtlinie 2006/42/EG
EMV-Richtlinie 2014/30/EU

Directive on machinery 2006/42/EC
EMC directive 2014/30/EU

Directive relative aux machines 2006/42/CE
Directive CEM 2014/30/UE

Aussteller
Issuer
Editeur

Konformitätsbeauftragter
Representative for conformity
Responsable de la conformité



R. Winkler
(COO)

Bottmingen, 13. Feb. 2023

Ort, Datum
Place, date
Lieu, date

13 Index

A

Accessories	33
box for microtitre plates	45
eve	48
Sticky Stuff	40
tray with clamping assembly	37
tray with pin holders	36
tray with sliding bars	39
tray with steel clamps	36
universal table tray	35
Air vents	29
Alarm messages	73
Allowed cultivation vessels	16
Auxiliary materials	91

B

Base	30
Box for microtitre plates	
mount	57
overview	45
Buttons	11

C

Changing locations	49
Clamps	
mount	57
plastic	44
stainless steel	44
Cleaning	
base tray	81
basic unit	80
Sticky Stuff	41
Commissioning	49
Conditions	
at the storage location	83
Connection	
Ethernet	28
power supply	27
USB	28
Connection values, electrical	88
Cooling	
functional description	26
refrigerant	91
specification	89
Cooling liquids	91
Cross-flow fan	25
Cultivation vessels	16

D

Declaration of decontamination	22
Decommissioning	70
Detergent	80, 91
Device	
cleaning	80
disinfect	81
install	49
loading	56, 59
maintain	79
positioning	51
transport	83
Device fuses	
replace	78
specification	88
Device identification	32
Dimension drawings	
single unit	85
three units stacked	86
two units stacked	85
Dimensions	87, 88
Discharge outlet	29
Disinfectants	91
Disinfection	81
Display elements	12
Display IP address	69
Displaying the remaining time of the timer	66
Distances	51
Door lock	54
Door monitoring	21

E

Electric connection values	88
Emergency shut-off	30
Emissions	89
Environmental conditions	
installation location	49, 90
storage	83
Equipment	
deactivate	70
switch on	53
Equipment fuses	
position	21
Erlenmeyer flasks, requirements	16
Err	74
Error messages	74
shaker drive	74
temperature control	74

Index

Ethernet interface	
position	28
use	68
eve	48
Exterior dimensions	88
F	
F button	11
Fan	25
Fault messages	74
Fernbach flasks, requirements	16
Flasks	16
Frame	30
FT button	11
Functional description	
cooling	26
shaking	23
temperature control	25
Fuses	
position	21
replace	78
specification	88
H	
Heating	93
Hi	73
Holders	
mount	57
overview	43
screw sizes	58
I	
Identification of the throw	32
Identification plate	32
Incorrect use	15
Initial commissioning	49
Installation	49
Installation location	49
Intended use	15
Interfaces	88
Interferences	
general faults	75
shaker drive	76
temperature control	76
Interior dimensions	88
Interior lighting	
position	27
specification	89
Interrupted power supply	71
L	
LED display	13
Lighting	
position	27
specification	89
Lo	73
Load capacity	94
Loading	56, 59
M	
Main switch	30
Mains connection	27
Maintenance	79
Maintenance plan	79
Materials	89
Maximum rotation speeds	
single unit	92
three units stacked	92
two units stacked	92
with box for microtitre plates	47
with Sticky Stuff	43
Messages	
Err	74
Hi	73
Lo	73
P. out	71, 73
Microtitre box	
mount	57
overview	45
Minimum distances	51
Minus button	11
Misuse	15
Motor	
operating time	69
specification	91
O	
On/Off button	11
Opening the door	54
Operating conditions	49, 90
Operating elements	11
Operating panel	
display elements	12
operating elements	11
overview	31
time information	13
view boxes	13
Operating time counter	69
Operation	
activating parameters	60
deactivating parameters	61

setting the parameter setpoint	60	Rotation speeds	
switch the device on	53	single unit	92
switching off the device	70	three units stacked	92
timer	61	two units stacked	92
Operator	17	with box for microtitre plates	47
Overheating shut-down	21	with Sticky Stuff	43
Overview		Rubber feet	30
accessories	33	S	
components	8	Safety features	21
display and operating elements	10	Screw sizes	
exterior	8	holders	58
interior	9	table	81
parameter	10	Serial number	32
timer function	61	Setpoint	
P		reachable, temperature	94
P. out	71, 73	set	60
Parameter		Setup	8
deactivate	61	Shaker drive	
setting the setpoint	60	error messages	74
switch on	60	functional description	23
Plus button	11	interferences	76
Positioning the device		operating time	69
on a bench	51	specification	91
under a bench	52	Shaking throw	
Power supply		marking	32
mains connection	27	shaker drive	91
requirements	50	Sound pressure	89
specification	88	Specification	
Power switch	30	basic unit	87
Protection classes	15	cooling	89
Protection type	90	cultivation vessels	16
Provider	18	heating	93
Provider obligations	18	shaker drive	91
Pt100	93	ventilation	93
Purpose of use	15	Sticky Stuff	
Q		maximum rotation speeds	43
Quickload spacer	37	overview	40
R		Sticky Stuff adhesive matting	40
Rating plate	32	Storage	83
Refrigerant	91, 93	Substructure	30
Requirements		Switch on	53
at the installation site	49	Switching off	70
Requirements for qualified personnel	17	Symbols	
Responsibility of the provider	18	on the device	22
Ring spacer	36	on the operating panel	12
Risk classes	15	T	
Room temperature	90	Table	
		dismantling	81
		mount	81
		overview	23

Index

screw size	81	W	
stop automatically	54	Weight	87
Technician	18	Working light	
Temperature control		position	27
error messages	74	specification	89
functional description	25		
interferences	76		
operating time	69		
specification	93		
temperatures that can be reached	94		
Test tube holder			
mount	57		
overview	45		
Three units stacked			
dimension drawings	86		
permissible rotation speeds	92		
Throw	32, 91		
Time information	13		
Timer function			
cancel	67		
cyclic change	63		
displaying the remaining time	66		
interrupted power supply	71		
one-time change	62		
programme	63		
Transport	83		
Tray			
can be equipped freely	35		
insert	56		
mount the holders	57		
remove	56		
with clamping assembly	37		
with pin holders	36		
with sliding bars	39		
with steel clamps	36		
with Sticky Stuff	40		
Tray lock	55		
Two units stacked			
dimension drawings	85		
permissible rotation speeds	92		
U			
Universal table tray	35		
USB connection	28		
V			
Ventilation	93		
Vibrations	76		
View boxes	13		

Index

Digitize your bioprocesses

The platform software for your bioprocesses



eve® – the Bioprocess Platform Software

Able to do more than just plan, control and analyze your bioprocesses, eve® software integrates workflows, devices, bioprocess information and big data in a platform that lets you organize your projects in the cloud, no matter how complex they are.

Learn more at www.infors-ht.com/eve